

# Quick-Fittig Type Ejector Vacuum Generator

## Features

- The Vacuum Generator, creating vacuum by use of compressed air, can be used in combination with a Vacuum Pad to convey materials.
- Vacuum Generator comes in a variety of performances and types to meet your applications.

## Specification

Fluid admitted	Air	
Service pressure range	21.3~100psi	0.15 ~ 0.7MPa
Rated supply pressure	71.1psi (49.8psi)	0.5MPa (0.35MPa)
Service temperature range	32 ~ 140°F	0 ~ 60°C

## VB-VUSM Vaccume switch specification

Pressure sensing mode	Diaphragm micro switch
Fluid admitted	Air
Service temperature range	32~140°F (0 ~ 60°C) (No freezing)
Rated power	3A 250V
Pressure setting range	-5.9~-19.7in. Hg (-20~-67KPa)
Accuracy	±1.6in. Hg (±5KPa)
Differential response	2.0~4.7in. Hg (7~16KPa)
Set value at shipment	-15.7in. Hg (-53KPa)

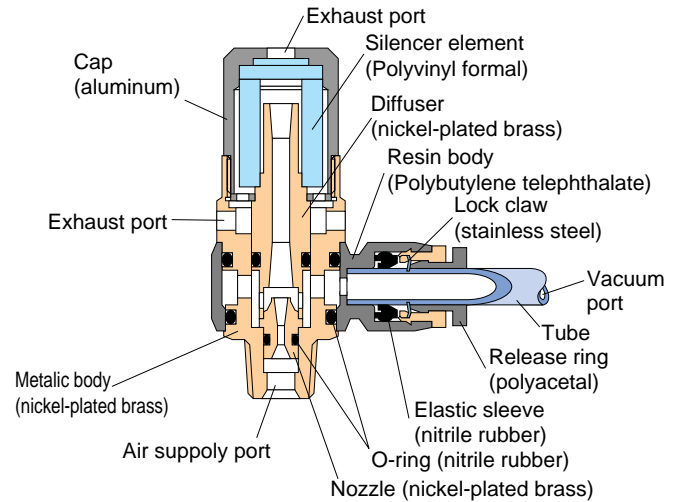

## Model Designation (Example)

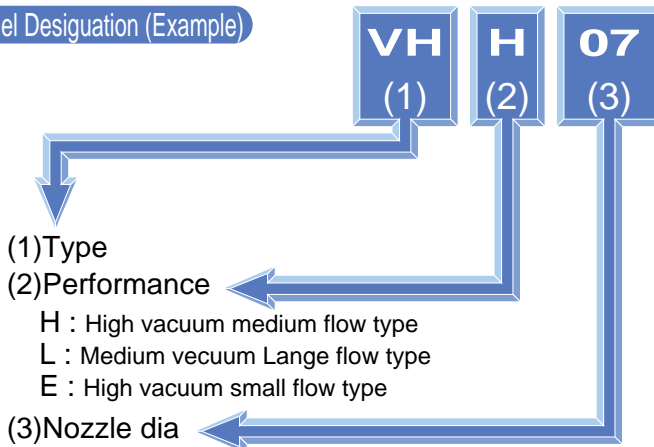

Code	Size	H Type vacuum level suction flow	L Type vacuum level suction flow	E Type vacuum level suction flow
05	0.5mm	-26.8in.Hg(-90KPa) 0.25SCFM(7Nℓ/min)	-19.7in.Hg(-67KPa) 0.42SCFM(12Nℓ/min)	—
07	0.7mm	-27.2~-27.6in.Hg(-90~-93KPa) 0.44~0.46SCFM(12.5~13Nℓ/min)	-19.7in.Hg(-67KPa) 0.78~0.92SCFM(22~26Nℓ/min)	-26.8~-27.2in.Hg(-92KPa) 0.35~0.37SCFM(10~10.5Nℓ/min)
10	1.0mm	-27.6in.Hg(-93KPa) 0.99SCFM(28Nℓ/min)	-19.7in.Hg(-67KPa) 1.48SCFM(42Nℓ/min)	-27.2in.Hg(-92KPa) 0.74SCFM(21Nℓ/min)
12	1.2mm	-27.6in.Hg(-93KPa) 1.34SCFM(38Nℓ/min)	—	-27.2in.Hg(-92KPa) 0.95SCFM(27Nℓ/min)
15	1.5mm	-27.6in.Hg(-93KPa) 2.22SCFM(63Nℓ/min)	-19.7in.Hg(-67KPa) 3.35SCFM(95Nℓ/min)	-27.2in.Hg(-92KPa) 1.48SCFM(42Nℓ/min)
20	2.0mm	-27.6in.Hg(-93KPa) 3.88SCFM(110Nℓ/min)	-19.7in.Hg(-67KPa) 6.35SCFM(180Nℓ/min)	-27.2in.Hg(-92KPa) 2.96SCFM(84Nℓ/min)

\*Air supply pressure is 0.5MPa (71.1psi) for H and L types or 0.35MPa (49.8psi) for E type.

## (4) Vacuum Port size

### ■ Tube dia

Tube dia	mm size			in. size						
Code	4	6	8	10	12	5/32	1/4	5/16	3/8	1/2
Size	φ4	φ6	φ8	φ10	φ12	φ5/32	φ1/4	φ5/16	φ3/8	φ1/2

### ■ Thread size

Thread size	Metric thread(mm)			Taper pipe thread			Unified fine thread			American standard Taper pipe thread	
Code	M5	M6	01	02	03	U10	N1	N2			
Size	M5×0.8	M6×0.8	R1/8	R1/4	R3/8	10-32UNF	NPT1/8	NPT1/4			

## (5) Air supply port size

### ■ Tube dia

Tube dia	mm size			in. size						
Code	4	6	8	10	12	5/32	1/4	5/16	3/8	1/2
Size(mm)	φ4	φ6	φ8	φ10	φ12	φ5/32	φ1/4	φ5/16	φ3/8	φ1/2

### ■ Thread size

Thread size	Metric thread(mm)			Taper pipe thread			Unified fine thread			American standard Taper pipe thread	
Code	M5	M6	01	02	03	U10	N1	N2			
Size	M5×0.8	M6×0.8	R1/8	R1/4	R3/8	10-32UNF	NPT1/8	NPT1/4			

## (6) Additional feature

- J : Concentrated Exhaust type (VH, VS, VU)
- A : Disassembly type (VU)

## (7) Hexagon flat-to-flat specification

- U: Hexagon flat-to-flat inch spec. (NPT)
- No code: Hexagon flat-to-flat mm spec.

## Characteristics

### Pressure supply-Final Vacuum, Vacuum flow, Air consumption

VHH 05 VHL 05  
VSH 05 VSL 05  
VBH 05 VBL 05  
VGH 05 VGL 05

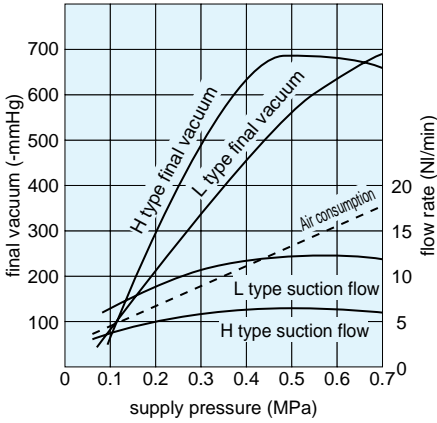

VHH 07 VHL 07 VHE 07  
VSH 07 VSL 07 VSE 07  
VBH 07 VBL 07 VBE 07  
VGH 07 VGL 07 VGE 07

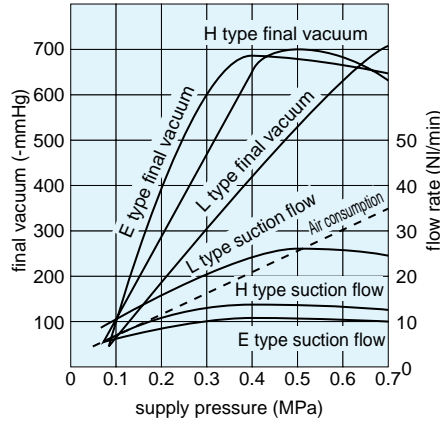

VHH 10 VHL 10 VHE 10  
VSH 10 VSL 10 VSE 10  
VBH 10 VBL 10 VBE 10  
VGH 10 VGL 10

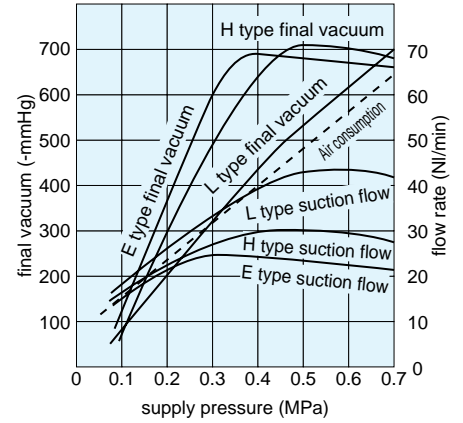

VHH 12 VHL 12  
VSH 12 VSL 12  
VBH 12 VBL 12

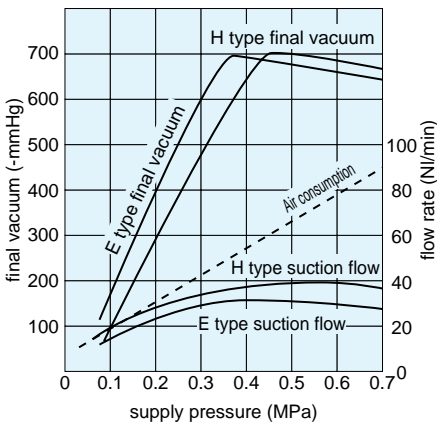

VHH 15 VHL 15 VHE 15  
VSH 15 VSL 15 VSE 15

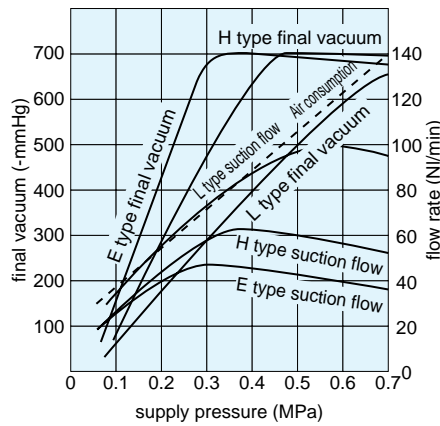

VUH 05 VUL 05  
VMH 05 VML 05  
VCH 05 VCL 05

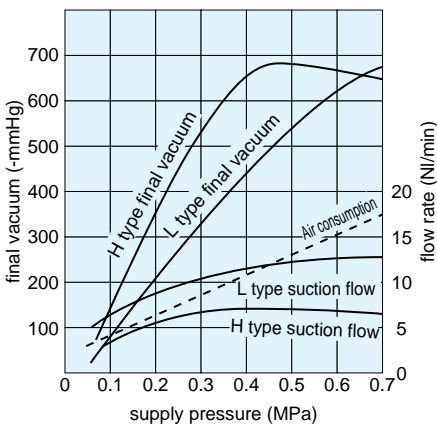

VUH 07 VUL 07 VUE 07

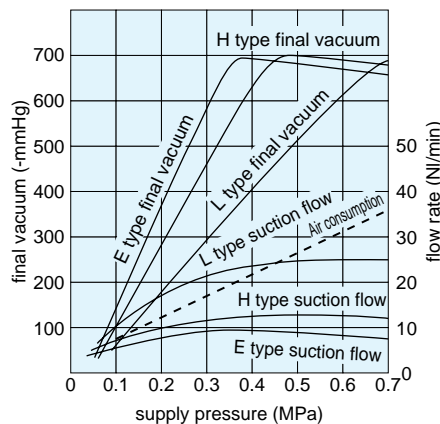

## Charactoristics

Evacuation time [Supply pressure H type : 0.5MPa(72.5psi), L type : 0.5MPa(72.5psi),E type : 0.3-0.5MPa(43.5~72.5psi)]

\* These figures depend on the layout of vacuum system.

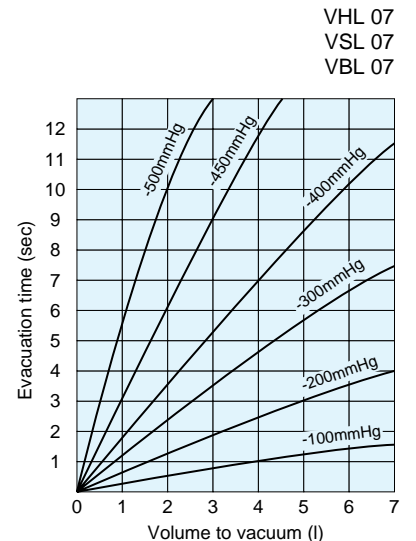
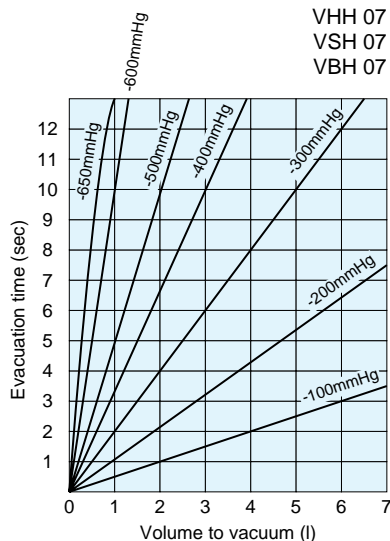
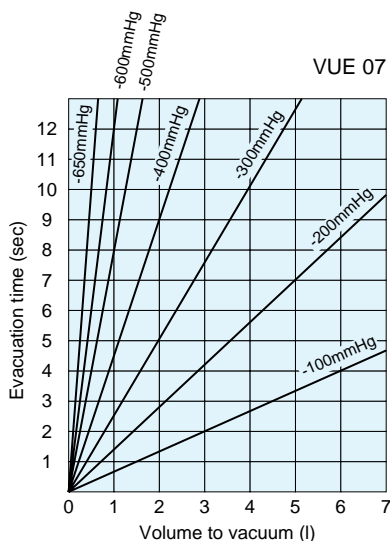
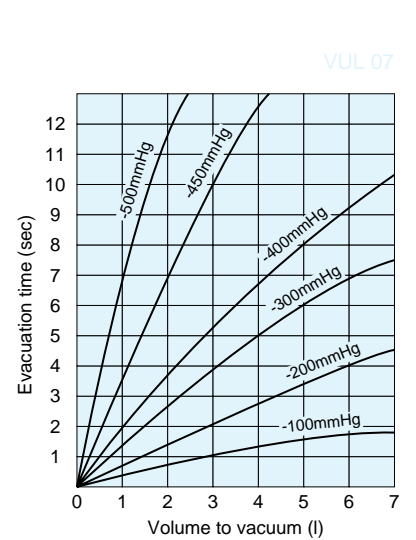
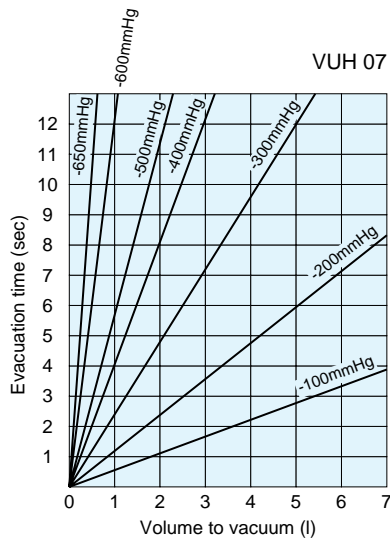
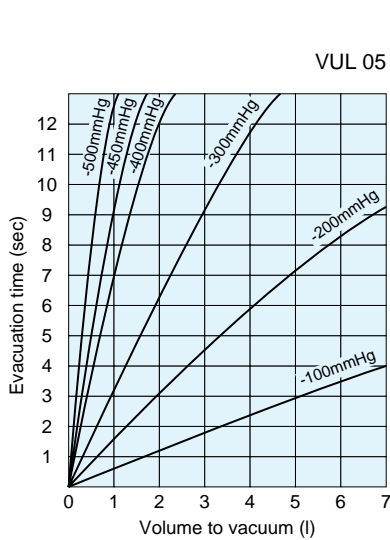
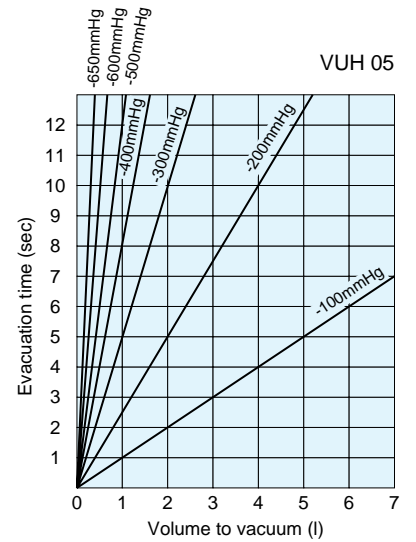
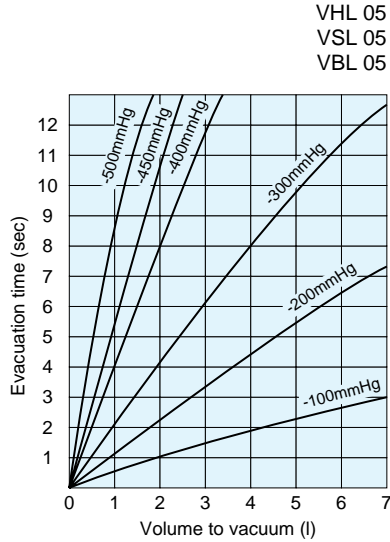
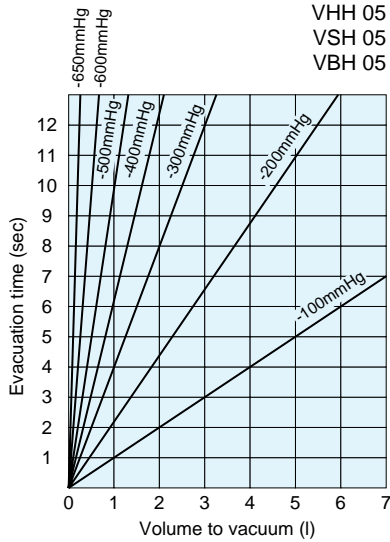

## Characteristics

Evacuation time [Supply pressure H type : 0.5MPa(72.5psi), L type : 0.5MPa(72.5psi), E type : 0.3-0.5MPa(43.5~72.5psi)]

\* These figures depend on the layout of vacuum system.

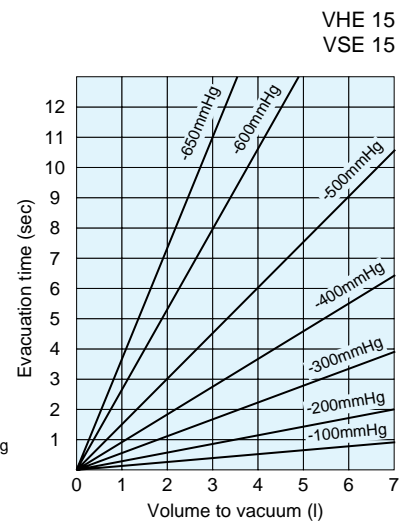
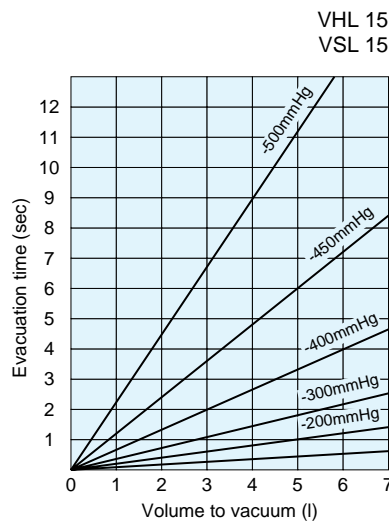
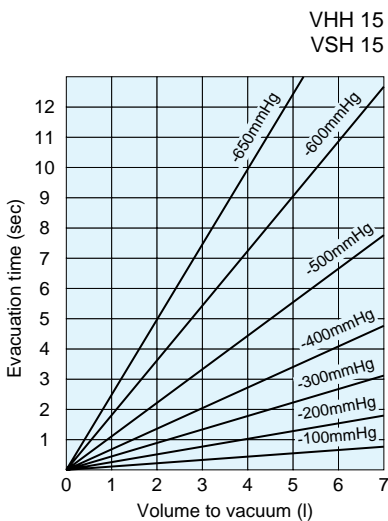
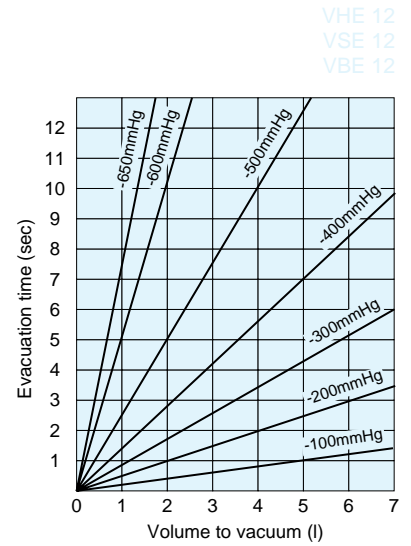
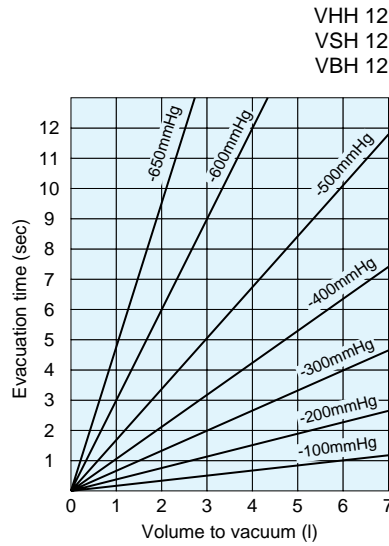
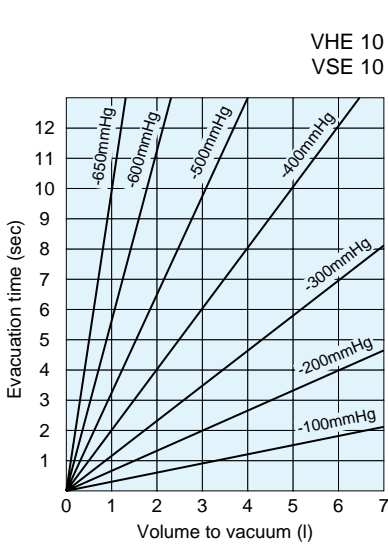
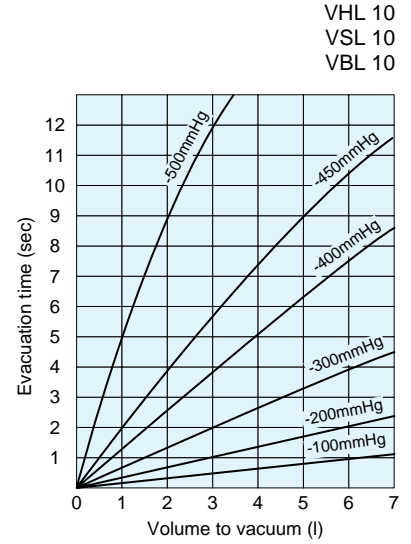
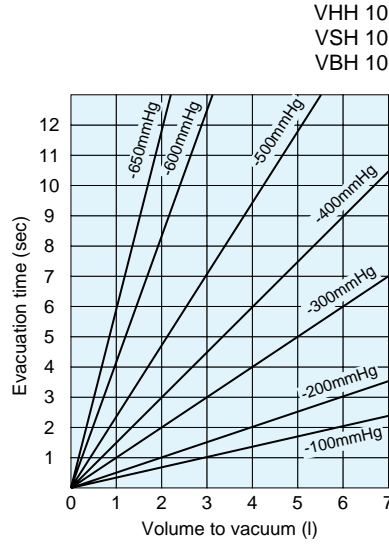
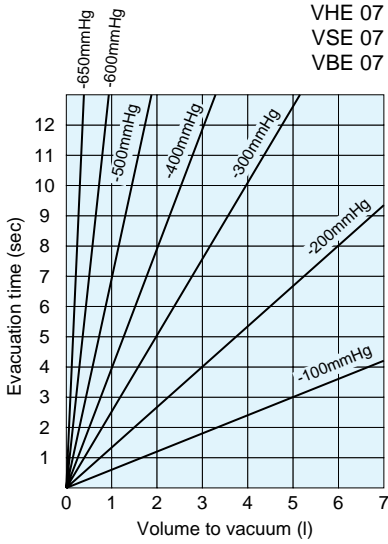

## How to select

■ Three different types of vacuum generators, H type (high vacuum), L type (large vacuum flow) and E type (low consumption-high vacuum), are provided to meet your requirements.

### ● H type - E type

When your primary concern is to get a high vacuum level; where 0.5MPa(72.5psi) of compressed air can be secured H type is suitable, and where it cannot be secured or air consumption needs to be lowered, E type is preferable.

### ● H type - L type

Where high vacuum is required, H type is recommended. When the vacuum needs to be adjusted, L type can be used to set the vacuum at a desired level by adjusting the pressure of the supply air with a regulator. Vacuum level of L type is almost in proportion to the force of supply air.

During the pressure range of 0.2~0.6MPa(29~87psi), L type is designed to set the vacuum level at; -27KPa(7.9in. Hg) at 0.2MPa(29psi), -40KPa(11.8in. Hg) at 0.3MPa(43.5psi), -54KPa(15.7in. Hg) at 0.4MPa(58psi), -67KPa(19.7in. Hg) at 0.5MPa(72.5psi), -80KPa(23.6in. Hg) at 0.6MPa(87psi). Although there is some differential between -5% to +15% against the setting level, it is still possible to set the vacuum level by adjusting the supply air pressure.

### ● When the vacuum cups do not hold the surface of works perfectly:

When the works cannot be held tight by vacuum cups (due to air leak), how to decide which type, H type or L type, should be used depends on the vacuum level in the vacuum system.

According to the vacuum level-vacuum flow table at the right, when the vacuum level in vacuum system is over -54KPa(15.7in. Hg), H type is preferable. When under -40KPa(11.8in. Hg), L type is better.

L Type Final Vacuum Characteristics

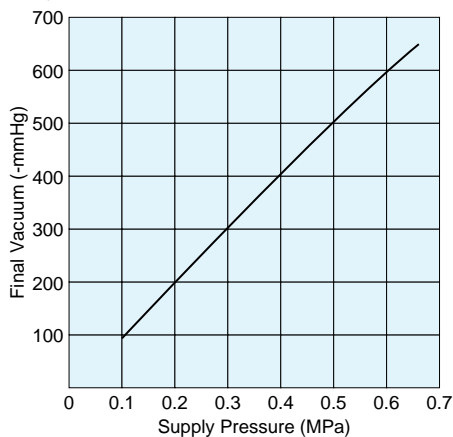

(Fig.1)

VHH 10, VHL 10 Vacuum level-Suction flow

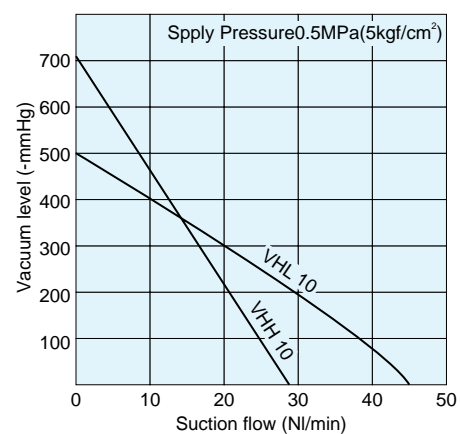

(Fig.2)

## Remarks

### ● Valve

When solenoid valves or other valves are used in the system, ones that can secure adequate air flow should be used. (Valves' effective sectional areas should be three times bigger than the nozzle's cross section).

### ● Vacuum piping

Because the piping resistivity of vacuum system is bigger than you expect, we'd recommend you to make the vacuum piping as short as possible and to use a tube whose dia. is bigger than the general one. Especially, when vacuum switches are used in the system, too much piping resistance might cause wrong operations. It might also cause a reduction of vacuum flow.

### ● Piping for air supply side

It is necessary to pay attention to the piping on the air supply side. Piping should be done in order to secure the rated pressure at the point of the inlet port of vacuum generator.

---

 Detailed Safety Instructions

Before using the PISCO device, be sure to read the "Safety Instructions", "Common Safety Instructions for Products Listed in This Manual" on pages 23~24 and "Common Safety Instructions for Vacuum" on pages 379~380 and "Common Safety Instructions for Mechanical Vacuum Switches" on page 381.

 **Caution**

1. Note that with the VC type (M5 only) piping can not be changed after installation of the body.

# Vacuum Series Vacuum Generator



## VC

Pad Direct-Mounting  
Straight

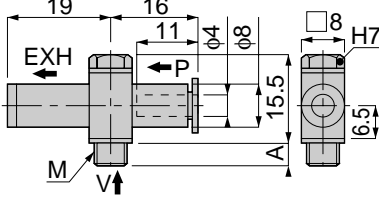

Model	M	A	Nozzle dia. (mm)	Final vacuum (-KPa)	Suction flow (Nℓ/min)	Air consumption (Nℓ/min)	Mass (g)
VCH 05-M54	M5×0.8	3	0.5	91	7	11.5	14.5
VCH 05-M64	M6×1	3.5					
VCL 05-M54	M5×0.8	3	0.5	67	11	11.5	17
VCL 05-M64	M6×1	3.5					



unit:mm



## VB

Box Type Union

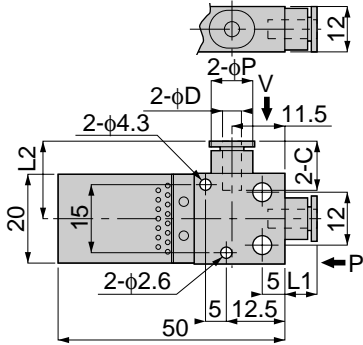

Model	Tube dia. φD	φP	C	Nozzle dia. (mm)	Supply Pressure (MPa)	Final vacuum (-KPa)	Suction flow (Nℓ/min)	Air consumption (Nℓ/min)	Mass (g)
VBH 05-44P	4	9	11	0.5	0.5(0.35)	91(73)	7(6.5)	11.5(9)	18
VBH 07-66P	6	10.5	11.5	0.7			13(13)	23(17)	
VBH 10-66P				1	28(28)	46(34)			
VBH 12-66P				1.2	38(36)	70(47)			
VBL 05-44P	4	9	11	0.5	0.45	67	12	11.5	18
VBL 07-66P	6	10.5	11.5	0.7			26	23	
VBL 10-66P				1			42	46	
VBE 07-66P	6	10.5	11.5	0.7	0.4	92	10.5	17	18.5
VBE 10-66P				1			21	34	
VBE 12-66P				1.2			27	47	



unit:mm

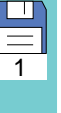

## VB

Box Type Union  
with Vacuum Switch

White Red Black

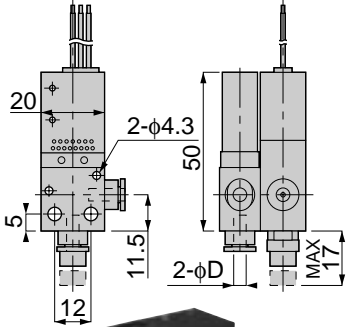

Model	Tube dia. φD	Nozzle dia. (mm)	Supply Pressure (MPa)	Final vacuum (-KPa)	Suction flow (Nℓ/min)	Air consumption (Nℓ/min)	Mass (g)		
VBH 05-44S	4	0.5	0.5(0.35)	91(73)	7(6.5)	11.5(9)	46.5		
VBH 07-66S	6	0.7						13(13)	23(17)
VBH 10-66S		1	28(28)	46(34)					
VBH 12-66S		1.2	38(36)	70(47)					
VBL 05-44S	4	0.5	0.45	67	12	11.5	46.5		
VBL 07-66S	6	0.7						26	23
VBL 10-66S		1						42	46
VBE 07-66S	6	0.7	0.4	92	10.5	17	48.5		
VBE 10-66S		1						21	34
VBE 12-66S		1.2						27	47

※Lead wire white : COMMON  
Red : NC  
Black : NO



unit:mm



## VUSM

Mechanical Vacuum Switch

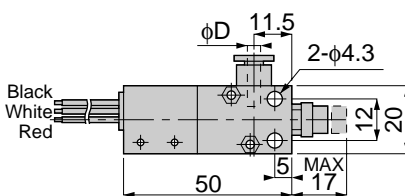

Model	Tube dia. φD	Mass (g)
VUSM 10-4	4	29
VUSM 10-6	6	29

※Lead wire white : COMMON  
Red : NC  
Black : NO



unit:mm

