



T Series

Tube Fitting & Speed Controller

Quick-fitting Joint for pneumatic piping and Speed Controller for driving devices

Tube Fitting

***Maintaining basic functions,
this low-cost quick-fitting joint
achieves high-cost performance.***



- *The Tube Fitting comes in a wide variety of tube and thread sizes.*
- *Even after installation the direction of the tubing can be changed freely (Elbow, Long Elbow, Universal Elbow, etc.).*

Construction

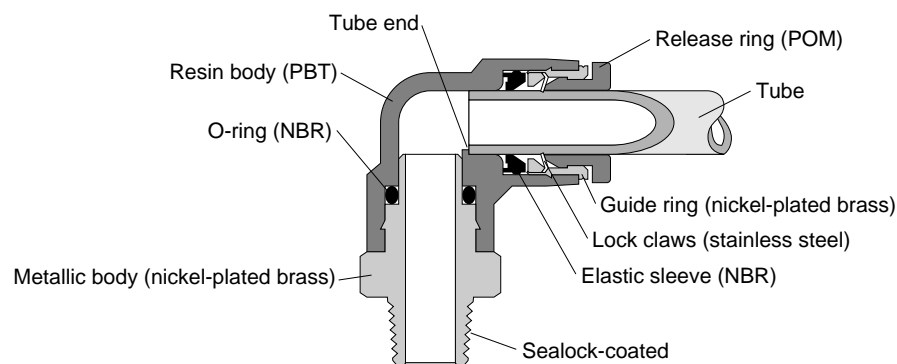

Tube Fitting

Specification

Fluid admitted	Air, water (conditional *1, *2, *3)
Max. Service pressure	150psi (0.9MPa)
Negative pressure	-29.5in. Hg (-100kPa)
Service temperature range	32 ~ 140°F (0 ~ 60°C)

*1. When it is used with water, please make sure that surge pressure is lower than Max. service pressure range.

*2. Fresh water is applicable. Please make an inquiry for other fluid uses.

*3. When it is used with water, be sure to install the insert ring.

Model Designation (example)

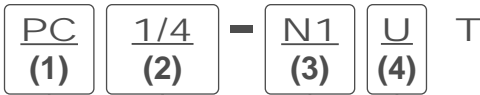

(4). Hexagon flat-to-flat specification

U: Hexagon flat-to-flat inch spec. (NPT)

NO CODE: Hexagon flat-to-flat mm spec.

(3). Thread size (R) or Tube dia. (øD)

	Metric thread	Taper pipe thread			
Code	M5	O1	O2	O3	O4
Size	M5 x 0.8	R1/8	R1/4	R3/8	R1/2
	Unified fine thread	American standard taper pipe thread			
Code	U10	N1	N2	N3	N4
Size	10-32UNF	NPT1/8	NPT1/4	NPT3/8	NPT1/2

(2). Tube dia. (øD) or Thread size (R)

	mm size				
Code	4	6	8	10	12
Dia. (mm)	4	6	8	10	12
	inch size				
Code	5/32	1/4	5/16	3/8	1/2
Dia. (inch)	5/32	1/4	5/16	3/8	1/2

(1). Type

Connection and Disconnection

1. How to fit and release Tubing

(1). Tube insertion

Simply insert a tubing to the tube end of Tube Fitting. The lock claws automatically fix the tubing, and the elastic sleeve seals the tube surrounding.

Please refer to "2. Cautions on the fitting of tube" in "Common Safety Instructions for Quick-Fitting Joint" for other instructions.

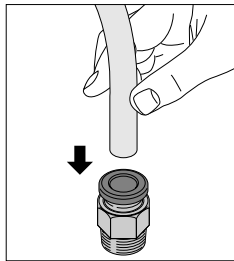

(2). Tube release

In case of releasing the tube, push the release ring. The lock claws open and the tube can be released.

Before releasing the tube, make certain that the pressure inside the tube is zero pressure.

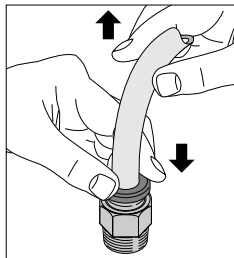

2. How to tighten the screw

For the type of tightening outside hexagon, apply a spanner or an impact wrench.

For the type of tightening inside hexagon (This enables to space Tube Fittings closer), apply a Hex Keys. (Please refer to the text for detail.)

Please refer to Table 3 Tightening Torque, Sealock color and Gasket Material in "4. Cautions on the installation of joint body" in "Common Safety Instructions for Quick-Fitting Joint".

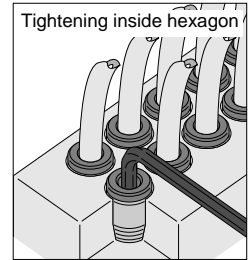
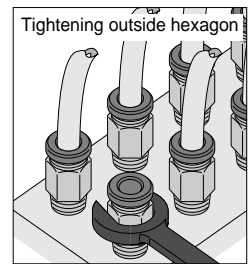

⚠ Detailed Safety Instructions

Before using the PISCO device, be sure to read the "Safety Instructions", "Common Safety Instructions for Products Listed in This Manual" on page 19 to 21 and "Common Safety Instructions for Quick-Fitting Joint" on page 22 to 23.

Warning

1. When the fluid admitted is water, do not use the PISCO device unless the application satisfies all the conditions required in specifications. Otherwise damage may be caused to the joint body, the tube may come off or leakage may result.

PC Straight



Appearance Dimension for Metric thread

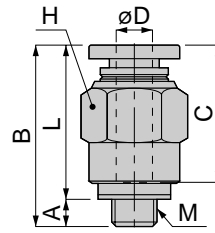

Appearance Dimension for Taper pipe thread (PT)

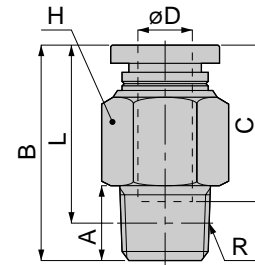

Unit: inch

Model	ØD (Tube dia.)	M/R	A	B	L	C	H (Hex.)	Weight (OZ)	Orifice dia. (mm)	Eff. sect. Area (mm ²)	Cv
PC4-M5T	4	M5 x 0.8	0.12	0.79	0.67	0.59	0.39	0.22	1.8	1.9	0.10
PC4-01T		R1/8	0.31	0.83				0.29	3	5.3	0.29
PC6-M5T	6	M5 x 0.8	0.12	0.87	0.75	0.67	0.47	0.32	1.8	1.9	0.10
PC6-01T		R1/8	0.31	0.89					0.61	4.6	12.5
PC6-02T		R1/4	0.43	0.97				0.55		6	20
PC8-01T	8	R1/8	0.31	1.10	0.94	0.72	0.55	0.55	7	20	1.08
PC8-02T		R1/4	0.43	1.05							
PC8-03T		R3/8	0.47	0.94				0.69	0.67	0.83	
PC10-02T	10	R1/4	0.43	1.17	0.94	0.81	0.67	0.72	8.5	35	1.90
PC10-03T		R3/8	0.47	1.15				0.91			
PC12-03T	12	R3/8	0.47	1.26	1.01	0.92	0.83	1.26	11	59	3.20
PC12-04T		R1/2	0.59	1.33				1.76			



Appearance Dimension for Unified thread

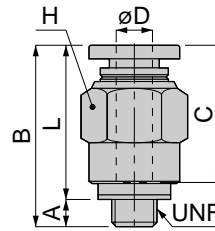

Appearance Dimension for Pipe thread general purpose (NPT)

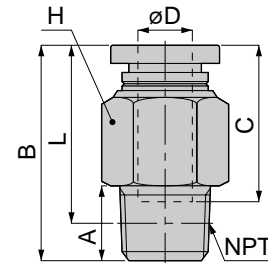

Unit: inch

Model	ØD (Tube dia.)	UNF/NPT	A	B	L	C	H (Hex.)	Weight (OZ)	Orifice dia. (mm)	Eff. sect. Area (mm ²)	Cv
PC5/32-U10UT	5/32	No. 10-32UNF	0.12	0.79	0.67	0.59	7/16	0.22	1.8	1.9	0.10
PC5/32-N1UT		NPT1/8	0.31	0.83				0.29	3	5.3	0.29
PC1/4-U10UT	1/4	No. 10-32UNF	0.12	0.87	0.75	0.67	1/2	0.32	1.8	1.9	0.10
PC1/4-N1UT		NPT1/8	0.31	0.89							
PC1/4-N2UT		NPT1/4	0.43	0.97				0.74			
PC5/16-N1UT	5/16	NPT1/8	0.31	1.10	0.94	0.72	9/16	0.55	6	20	1.08
PC5/16-N2UT		NPT1/4	0.43	1.05				0.82	0.55		
PC5/16-N3UT		NPT3/8	0.47	0.94				0.70	0.83		
PC3/8-N2UT	3/8	NPT1/4	0.43	1.17	0.94	0.81	11/16	0.72	8.5	35	1.90
PC3/8-N3UT		NPT3/8	0.47	1.15				0.91			
PC1/2-N3UT	1/2	NPT3/8	0.47	1.26	1.02	0.92	7/8	1.26	11	59	3.20
PC1/2-N4UT		NPT1/2	0.59	1.33				1.76			

Tube Fitting

PU Union Straight

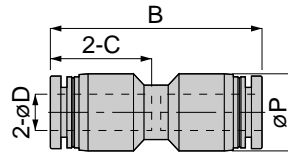

Unit: inch

Model	ØD (Tube dia.)	B	C	øP	Weight (OZ)	Orifice dia. (mm)	Eff. sect. Area (mm ²)	Cv
PU4T	4	1.21	0.59	0.39	0.17	2.8	3.8	0.21
PU6T	6	1.37	0.67	0.49	0.24	4.3	11.4	0.62
PU8T	8	1.49	0.72	0.57	0.33	5.9	25.4	1.38
PU10T	10	1.63	0.80	0.69	0.55	8.3	36.7	1.99
PU12T	12	1.88	0.92	0.83	0.80	9.9	47.4	2.57

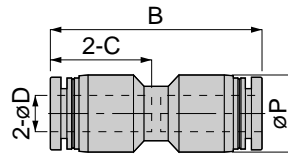

Unit: inch

Model	ØD (Tube dia.)	B	C	øP	Weight (OZ)	Orifice dia. (mm)	Eff. sect. Area (mm ²)	Cv
PU5/32T	5/32	1.21	0.59	0.39	0.17	2.8	3.8	0.21
PU1/4T	1/4	1.37	0.67	0.49	0.24	4.3	11.4	0.62
PU5/16T	5/16	1.49	0.72	0.57	0.33	5.9	25.4	1.38
PU3/8T	3/8	1.63	0.80	0.69	0.55	8.3	36.7	1.99
PU1/2T	1/2	1.88	0.92	0.83	0.80	9.9	47.4	2.57

PG Different Diam. Union Straight

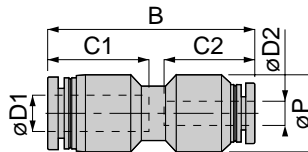

Unit: inch

Model	ØD1 (Tube dia.)	ØD2 (Tube dia.)	B	C1	C2	øP	Weight (OZ)	Orifice dia. (mm)	Eff. sect. Area (mm ²)	Cv
PG6-4T	6	4	1.35	0.67	0.59	0.49	0.23	2.8	4.9	0.27
PG8-6T	8	6	1.49	0.72	0.67	0.57	0.31	4.3	6.3	0.34
PG10-8T	10	8	1.62	0.80	0.72	0.69	0.49	5.9	28.8	1.56
PG12-10T	12	10	1.87	0.92	0.80	0.83	0.76	8.3	39.9	2.16

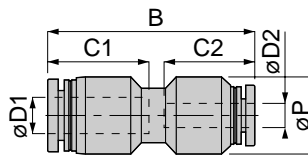

Unit: inch

Model	ØD1 (Tube dia.)	ØD2 (Tube dia.)	B	C1	C2	øP	Weight (OZ)	Orifice dia. (mm)	Eff. sect. Area (mm ²)	Cv
PG1/4-5/32T	1/4	5/32	1.35	0.67	0.59	0.49	0.23	2.8	4.9	0.27
PG5/16-1/4T	5/16	1/4	1.49	0.72	0.67	0.57	0.31	4.3	6.3	0.34
PG3/8-5/16T	3/8	5/16	1.62	0.80	0.72	0.69	0.49	5.9	28.8	1.56
PG1/2-3/8T	1/2	3/8	1.87	0.92	0.80	0.83	0.76	8.3	39.9	2.16

PL Elbow



Appearance Dimension for Metric thread

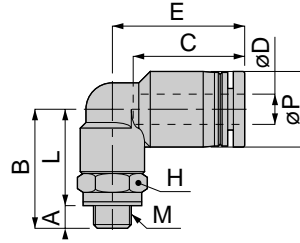

Appearance Dimension for Taper pipe thread (PT)

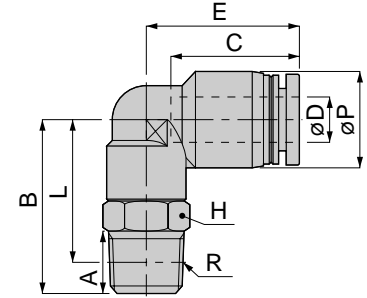

Unit: inch

Model	ØD (Tube dia.)	M/R	A	B	L	E	C	øP	H (Hex.)	Weight (OZ)	Orifice dia. (mm)	Eff. sect. Area (mm ²)	Cv	
PL4-M5T	4	M5 × 0.8	0.12	0.63	0.51	0.70	0.59	0.39	0.31	0.20	2.4	3.7	0.20	
PL4-01T		R1/8	0.31	0.87	0.71	0.74			0.39	0.38	2.8	4.5	0.24	
PL6-M5T	6	M5 × 0.8	0.12	0.77	0.65	0.80	0.67	0.49	0.39	0.46	1.8	1.5	0.08	
PL6-01T		R1/8	0.31	0.89	0.73				0.42	4	9	0.49		
PL6-02T		R1/4	0.43	1.10	0.87				0.86	0.55	0.70	4.3	10	0.54
PL8-01T	8	R1/8	0.31	0.91	0.75	0.89	0.72	0.57	0.47	0.48	6	18.8	1.02	
PL8-02T		R1/4	0.43	1.10	0.87				0.93	0.55	0.76	6.4	23.5	1.27
PL8-03T		R3/8	0.47	1.22	0.97				0.97	0.67	1.21		20.3	1.10
PL10-02T	10	R1/4	0.43	1.12	0.89	1.02	0.80	0.69	0.55	0.87	7.5	29.5	1.60	
PL10-03T		R3/8	0.47	1.26	1.01				1.06	0.67	1.33	8.2	32.1	1.74
PL12-03T	12	R3/8	0.47	1.28	1.03	1.17	0.92	0.83	0.67	1.46	9	43	2.33	
PL12-04T		R1/2	0.59	1.44	1.11				0.83					

Appearance Dimension for Unified thread

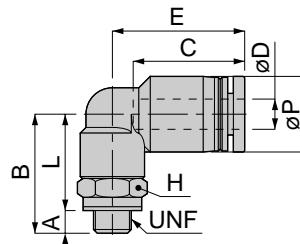

Appearance Dimension for Pipe thread general purpose (NPT)

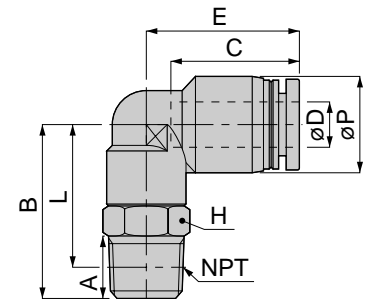

Unit: inch

Model	ØD (Tube dia.)	UNF/NPT	A	B	L	E	C	øP	H (Hex.)	Weight (OZ)	Orifice dia. (mm)	Eff. sect. Area (mm ²)	Cv	
PL5/32-U10UT	5/32	No. 10-32UNF	0.12	0.63	0.51	0.70	0.59	0.39	5/16	0.20	2.4	3.7	0.20	
PL5/32-N1UT		NPT1/8	0.31	0.87	0.70	0.74			7/16	0.38	2.8	4.5	0.24	
PL1/4-U10UT	1/4	No. 10-32UNF	0.12	0.77	0.65	0.80	0.67	0.49	7/16	0.46	1.8	1.9	0.10	
PL1/4-N1UT		NPT1/8	0.31	0.89	0.72				0.42	4	9	0.49		
PL1/4-N2UT		NPT1/4	0.43	1.10	0.87				0.86	9/16	0.70	4.3	10	0.54
PL5/16-N1UT	5/16	NPT1/8	0.31	0.91	0.74	0.89	0.72	0.57	1/2	0.48	6	18.8	1.02	
PL5/16-N2UT		NPT1/4	0.43	1.10	0.87				0.93	9/16	0.76	6.4	23.5	1.27
PL5/16-N3UT		NPT3/8	0.47	1.22	0.98				0.97	11/16	1.21		20.3	1.10
PL3/8-N2UT	3/8	NPT1/4	0.43	1.12	0.89	1.02	0.80	0.69	9/16	0.87	7.5	29.5	1.60	
PL3/8-N3UT		NPT3/8	0.47	1.26	1.02				1.06	11/16	1.33	8.2	32.1	1.74
PL1/2-N3UT	1/2	NPT3/8	0.47	1.28	1.04	1.17	0.92	0.83	11/16	1.46	9	43	2.33	
PL1/2-N4UT		NPT1/2	0.59	1.44	1.12				7/8					

Tube Fitting

PLL Long Elbow

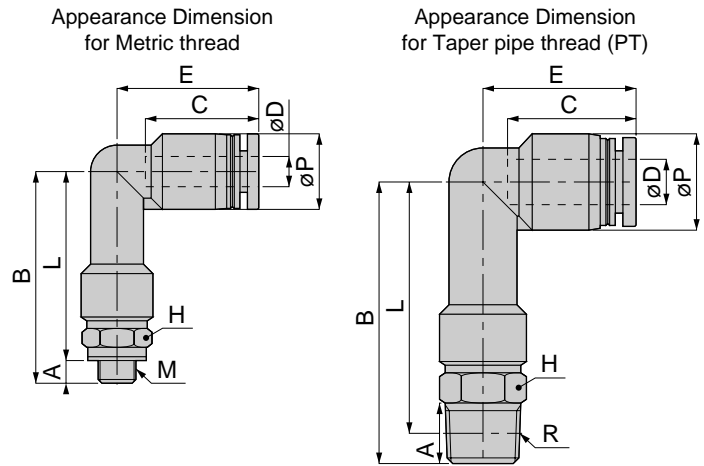

Unit: inch

Model	ØD (Tube dia.)	M/R	A	B	L	E	C	øP	H (Hex.)	Weight (OZ)	Orifice dia. (mm)	Eff. sect. Area (mm ²)	Cv
PLL4-M5T	4	M5 × 0.8	0.12	1.10	0.98	0.74	0.59	0.39	0.31	0.24	2.4	3.5	0.19
PLL4-01T		R1/8	0.31	1.34	1.18				0.39	0.42	2.8	4.3	0.23
PLL6-01T	6	R1/8	0.31	1.46	1.30	0.80	0.67	0.49	0.39	0.47	4	7.9	0.43
PLL6-02T		R1/4	0.43	1.67	1.44				0.55	0.81	4.3	10.4	0.56
PLL8-01T	8	R1/8	0.31	1.55	1.40	0.72	0.57	0.57	0.47	0.60	6	18.5	1.00
PLL8-02T		R1/4	0.43	1.75	1.52				0.55	0.87	6.5	19.3	1.05
PLL8-03T		R3/8	0.47	1.87	1.62				0.67	1.38		19.2	1.04
PLL10-02T	10	R1/4	0.43	1.89	1.65	1.02	0.80	0.69	0.55	1.01	7.5	27.8	1.51
PLL10-03T		R3/8	0.47	2.03	1.78				1.06	0.67	1.51	8.3	31.8
PLL12-03T	12	R3/8	0.47	2.18	1.94	1.17	0.92	0.83	0.67	1.66	9	43.5	2.36
PLL12-04T		R1/2	0.59	2.34	2.02				0.83				

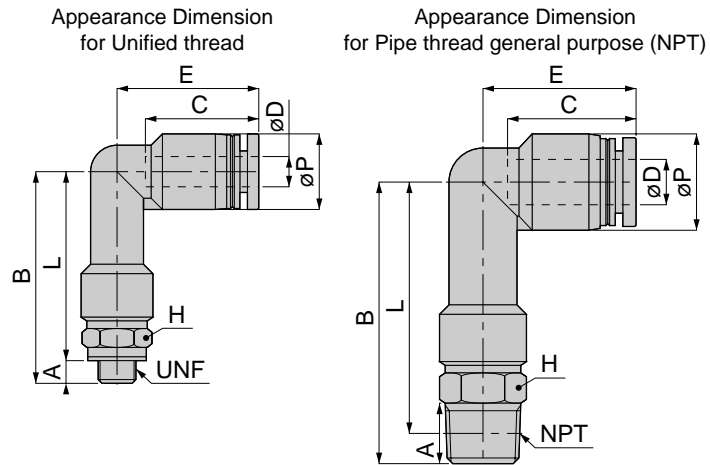

Unit: inch

Model	ØD (Tube dia.)	UNF/NPT	A	B	L	E	C	øP	H (Hex.)	Weight (OZ)	Orifice dia. (mm)	Eff. sect. Area (mm ²)	Cv
PLL5/32-U10UT	5/32	No. 10-32UNF	0.12	1.10	0.98	0.74	0.59	0.39	5/16	0.24	2.4	3.5	0.19
PLL5/32-N1UT		NPT1/8	0.31	1.34	1.18				7/16	0.42	2.8	4.3	0.23
PLL1/4-N1UT	1/4	NPT1/8	0.31	1.46	1.29	0.80	0.67	0.49	7/16	0.47	4	7.9	0.43
PLL1/4-N2UT		NPT1/4	0.43	1.67	1.44				9/16	0.81	4.3	10.4	0.56
PLL5/16-N1UT	5/16	NPT1/8	0.31	1.55	1.39	0.72	0.57	0.57	1/2	0.60	6	18.5	1.00
PLL5/16-N2UT		NPT1/4	0.43	1.75	1.52				9/16	0.87	6.5	19.3	1.05
PLL5/16-N3UT		NPT3/8	0.47	1.87	1.63				11/16	1.38		19.2	1.04
PLL3/8-N2UT	3/8	NPT1/4	0.43	1.89	1.66	1.02	0.80	0.69	9/16	1.01	7.5	27.8	1.51
PLL3/8-N3UT		NPT3/8	0.47	2.03	1.79				11/16	1.51	8.3	31.8	1.72
PLL1/2-N3UT	1/2	NPT3/8	0.47	2.18	1.94	1.17	0.92	0.83	11/16	1.66	9	43.5	2.36
PLL1/2-N4UT		NPT1/2	0.59	2.34	2.02				7/8				

PV Union Elbow

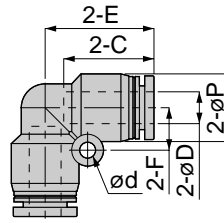

Unit: inch

Model	ØD (Tube dia.)	E	C	øP	F	ød	Weight (OZ)	Orifice dia. (mm)	Eff. sect. Area (mm ²)	Cv
PV4T	4	0.68	0.59	0.39	0.28	0.13	0.19	2.8	3.5	0.19
PV6T	6	0.81	0.67	0.49	0.31	0.13	0.26	4.3	8.7	0.47
PV8T	8	0.90	0.72	0.57	0.37	0.13	0.37	5.9	18.6	1.01
PV10T	10	1.03	0.80	0.69	0.43	0.17	0.61	8.3	28.4	1.54
PV12T	12	1.20	0.80	0.83	0.49	0.17	0.87	8.9	40.6	2.20

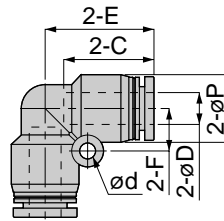

Unit: inch

Model	ØD (Tube dia.)	E	C	øP	F	ød	Weight (OZ)	Orifice dia. (mm)	Eff. sect. Area (mm ²)	Cv
PV5/32T	5/32	0.68	0.59	0.39	0.28	0.13	0.19	2.8	3.5	0.19
PV1/4T	1/4	0.81	0.67	0.49	0.31	0.13	0.26	4.3	8.7	0.47
PV5/16T	5/16	0.90	0.72	0.57	0.37	0.13	0.37	5.9	18.6	1.01
PV3/8T	3/8	1.03	0.80	0.69	0.43	0.17	0.61	8.3	28.4	1.54
PV1/2T	1/2	1.20	0.80	0.83	0.49	0.17	0.87	8.9	40.6	2.20

PE Union Tee

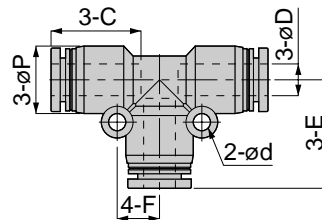

Unit: inch

Model	ØD (Tube dia.)	E	C	øP	F	ød	Weight (OZ)	Orifice dia. (mm)	Eff. sect. Area (mm ²)	Cv
PE4T	4	0.68	0.59	0.39	0.28	0.13	0.28	2.8	4	0.22
PE6T	6	0.81	0.67	0.49	0.31	0.13	0.39	4.3	11.3	0.61
PE8T	8	0.90	0.72	0.57	0.37	0.13	0.55	6.5	25.5	1.38
PE10T	10	1.03	0.80	0.69	0.43	0.17	0.90	8.3	37.5	2.03
PE12T	12	1.20	0.80	0.83	0.49	0.17	1.29	9.9	47.3	2.56

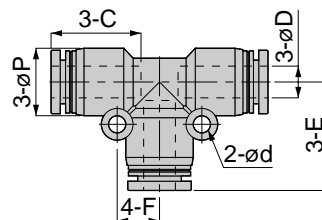

Unit: inch

Model	ØD (Tube dia.)	E	C	øP	F	ød	Weight (OZ)	Orifice dia. (mm)	Eff. sect. Area (mm ²)	Cv
PE5/32T	5/32	0.68	0.59	0.39	0.28	0.13	0.28	2.8	4	0.22
PE1/4T	1/4	0.81	0.67	0.49	0.31	0.13	0.39	4.3	11.3	0.61
PE5/16T	5/16	0.90	0.72	0.57	0.37	0.13	0.55	6.5	25.5	1.38
PE3/8T	3/8	1.03	0.80	0.69	0.43	0.17	0.90	8.3	37.5	2.03
PE1/2T	1/2	1.20	0.80	0.83	0.49	0.17	1.29	9.9	47.3	2.56

Tube Fitting

PB Tee



Appearance Dimension
for Metric thread

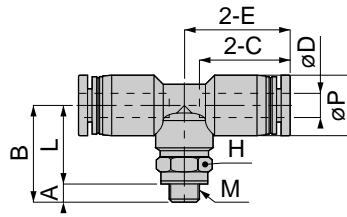

Appearance Dimension
for Taper pipe thread (PT)

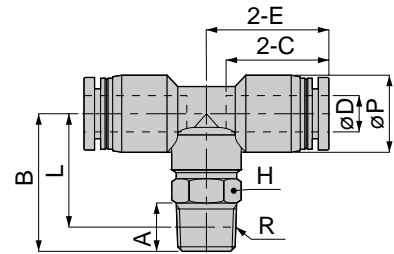

Unit: inch

Model	ØD (Tube dia.)	M/R	A	B	L	E	C	øP	H (Hex.)	Weight (OZ)	Orifice dia. (mm)	Eff. sect. Area (mm ²)	Cv
PB4-M5T	4	M5 × 0.8	0.12	0.63	0.51	0.70	0.59	0.39	0.31	0.29	2.4	3.6	0.20
PB4-01T		R1/8	0.31	0.87	0.71	0.74			0.39	0.47	2.8	6.1	0.33
PB6-01T	6	R1/8	0.31	0.89	0.73	0.80	0.67	0.49	0.39	0.54	4	10.2	0.55
PB6-02T		R1/4	0.43	1.10	0.87	0.86			0.55	0.83	4.3	13	0.70
PB8-01T	8	R1/8	0.31	0.91	0.75	0.89	0.72	0.57	0.47	0.64	6	23.8	1.29
PB8-02T		R1/4	0.43	1.10	0.87	0.93			0.55	0.91	6.4	34.3	1.86
PB8-03T		R3/8	0.47	1.22	0.97	0.97			0.67	1.38		33	1.79
PB10-02T	10	R1/4	0.43	1.12	0.89	1.02	0.80	0.69	0.55	1.15	7.5	37.3	2.02
PB10-03T		R3/8	0.47	1.26	1.01	1.06			0.67	1.61	8.2	46.4	2.51
PB12-03T	12	R3/8	0.47	1.28	1.03	1.17	0.92	0.83	0.67	1.86	9	45.6	2.47
PB12-04T		R1/2	0.59	1.44	1.11				0.83				

Appearance Dimension
for Unified thread

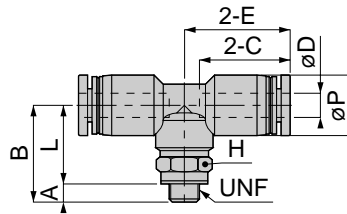

Appearance Dimension
for Pipe thread general purpose (NPT)

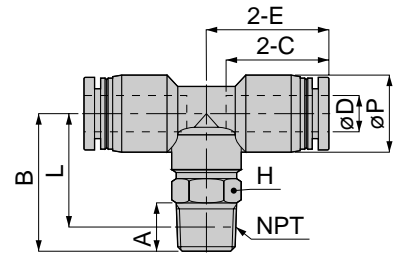

Unit: inch

Model	ØD (Tube dia.)	UNF/NPT	A	B	L	E	C	øP	H (Hex.)	Weight (OZ)	Orifice dia. (mm)	Eff. sect. Area (mm ²)	Cv
PB5/32-U10UT	5/32	No. 10-32UNF	0.12	0.63	0.51	0.70	0.59	0.39	5/16	0.29	2.4	3.6	0.20
PB5/32-N1UT		NPT1/8	0.31	0.87	0.70	0.74			7/16	0.47	2.8	6.1	0.33
PB1/4-N1UT	1/4	NPT1/8	0.31	0.89	0.72	0.80	0.67	0.49	7/16	0.54	4	10.2	0.55
PB1/4-N2UT		NPT1/4	0.43	1.10	0.87	0.86			9/16	0.83	4.3	13	0.70
PB5/16-N1UT	5/16	NPT1/8	0.31	0.91	0.74	0.89	0.72	0.57	1/2	0.64	6	23.8	1.29
PB5/16-N2UT		NPT1/4	0.43	1.10	0.87	0.93			9/16	0.91	6.4	34.3	1.86
PB5/16-N3UT		NPT3/8	0.47	1.22	0.98	0.97			11/16	1.38		33	1.79
PB3/8-N2UT	3/8	NPT1/4	0.43	1.12	0.89	1.02	0.80	0.69	9/16	1.15	7.5	37.3	2.02
PB3/8-N3UT		NPT3/8	0.47	1.26	1.02	1.06			11/16	1.61	8.2	46.4	2.51
PB1/2-N3UT	1/2	NPT3/8	0.47	1.28	1.04	1.17	0.92	0.83	11/16	1.86	9	45.6	2.47
PB1/2-N4UT		NPT1/2	0.59	1.44	1.12				7/8				

PD Branch Tee



Appearance Dimension for Metric thread

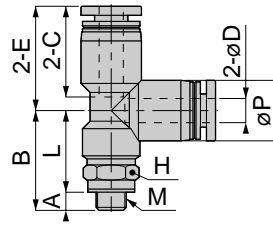

Appearance Dimension for Taper pipe thread (PT)

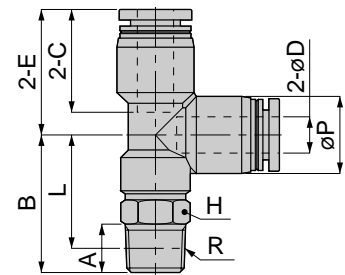

Unit: inch

Model	ØD (Tube dia.)	M/R	A	B	L	E	C	φP	H (Hex.)	Weight (OZ)	Orifice dia. (mm)	Eff. sect. Area (mm ²)	Cv
PD4-M5T	4	M5 x 0.8	0.12	0.65	0.53	0.68	0.59	0.39	0.31	0.29	2.4	3.4	0.18
PD4-01T		R1/8	0.31	0.91	0.75				0.39	0.47	2.8	5.2	0.28
PD6-01T	6	R1/8	0.31	0.90	0.74	0.81	0.67	0.49	0.39	0.54	4	10.4	0.56
PD6-02T		R1/4	0.43	1.11	0.87				0.55	0.82	4.3	13	0.70
PD8-01T	8	R1/8	0.31	0.91	0.75	0.90	0.72	0.57	0.47	0.65	6	24.3	1.32
PD8-02T		R1/4	0.43	1.13	0.90				0.55	0.92	6.5	33.4	1.81
PD8-03T		R3/8	0.47	1.24	0.99				0.67	1.37		32.3	1.75
PD10-02T	10	R1/4	0.43	1.12	0.89	1.03	0.80	0.69	0.55	1.14	7.5	38.2	2.07
PD10-03T		R3/8	0.47	1.26	1.01				0.67	1.61	8.3	46.6	2.53
PD12-03T	12	R3/8	0.47	1.30	1.05	1.20	0.92	0.83	0.67	1.87	9	45.9	2.49
PD12-04T		R1/2	0.59	1.46	1.13				0.83				

Appearance Dimension for Unified thread

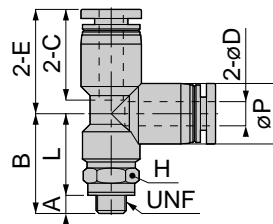

Appearance Dimension for Pipe thread general purpose (NPT)

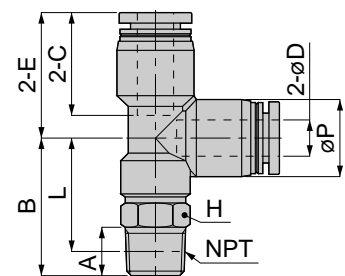

Unit: inch

Model	ØD (Tube dia.)	UNF/NPT	A	B	L	E	C	φP	H (Hex.)	Weight (OZ)	Orifice dia. (mm)	Eff. sect. Area (mm ²)	Cv
PD5/32-U10UT	5/32	No. 10-32UNF	0.12	0.65	0.53	0.68	0.59	0.39	5/16	0.29	2.4	3.4	0.18
PD5/32-N1UT		NPT1/8	0.31	0.91	0.74				7/16	0.47	2.8	5.2	0.28
PD1/4-N1UT	1/4	NPT1/8	0.31	0.90	0.73	0.81	0.67	0.49	7/16	0.54	4	10.4	0.56
PD1/4-N2UT		NPT1/4	0.43	1.11	0.89				9/16	0.82	4.3	13	0.70
PD5/16-N1UT	5/16	NPT1/8	0.31	0.91	0.74	0.90	0.72	0.57	1/2	0.65	6	24.3	1.32
PD5/16-N2UT		NPT1/4	0.43	1.13	0.91				9/16	0.92	6.5	33.4	1.81
PD5/16-N3UT		NPT3/8	0.47	1.24	1.00				11/16	1.37		32.3	1.75
PD3/8-N2UT	3/8	NPT1/4	0.43	1.12	0.89	1.03	0.80	0.69	9/16	1.14	7.5	38.2	2.07
PD3/8-N3UT		NPT3/8	0.47	1.26	1.02				11/16	1.61	8.3	46.6	2.53
PD1/2-N3UT	1/2	NPT3/8	0.47	1.30	1.06	1.20	0.92	0.83	11/16	1.87	9	45.9	2.49
PD1/2-N4UT		NPT1/2	0.59	1.46	1.14				7/8				

Tube Fitting

PH Universal Elbow



Appearance Dimension
for Metric thread

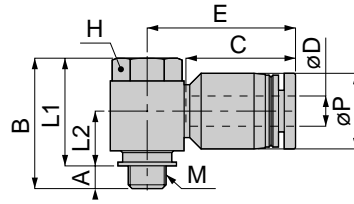

Appearance Dimension
for Taper pipe thread (PT)

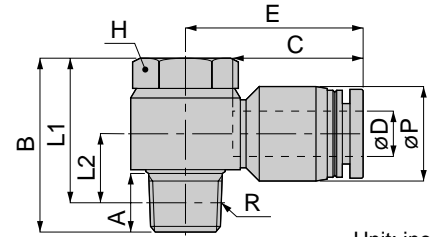

Unit: inch

Model	ØD (Tube dia.)	M/R	A	B	L1	L2	E	C	øP	H (Hex.)	Weight (OZ)	Orifice dia. (mm)	Eff. sect. Area (mm ²)	Cv
PH4-M5T	4	M5 x 0.8	0.12	0.67	0.55	0.28	0.78	0.59	0.39	0.31	0.26	2.4	2.6	0.14
PH4-01T		R1/8	0.31	0.97	0.81	0.42	0.84							
PH6-01T	6	R1/8	0.31	0.97	0.81	0.43	0.92	0.67	0.49	0.47	0.65	4.3	7.1	0.38
PH6-02T		R1/4	0.43	1.13	0.89	0.48	1.00							
PH8-01T	8	R1/8	0.31	0.97	0.81	0.47	1.06	0.72	0.57	0.47	0.71	6	9.9	0.54
PH8-02T		R1/4	0.43	1.13	0.89	0.52	1.12							
PH10-02T	10	R1/4	0.43	1.13	0.89	0.58	1.22	0.80	0.69	0.55	1.16	7.3	10.2	0.55
PH10-03T		R3/8	0.47	1.36	1.11	0.61	1.23							
PH12-03T	12	R3/8	0.47	1.36	1.11	0.68	1.45	0.92	0.83	0.75	2.29	9	20.3	1.10
PH12-04T		R1/2	0.59	1.62	1.30	0.74	1.43							

Appearance Dimension
for Unified thread

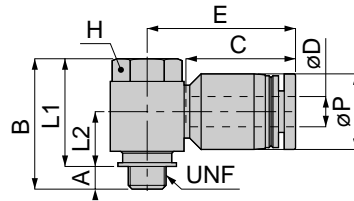

Appearance Dimension
for Pipe thread general purpose (NPT)

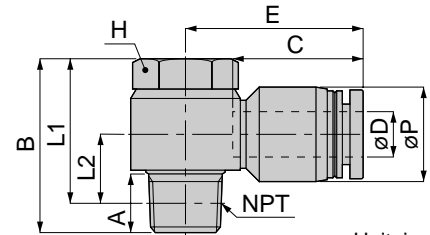

Unit: inch

Model	ØD (Tube dia.)	UNF/NPT	A	B	L1	L2	E	C	øP	H (Hex.)	Weight (OZ)	Orifice dia. (mm)	Eff. sect. Area (mm ²)	Cv
PH5/32-U10UT	5/32	No. 10-32UNF	0.12	0.67	0.55	0.28	0.78	0.59	0.39	5/16	0.26	2.4	2.6	0.14
PH5/32-N1UT		NPT1/8	0.31	0.97	0.81	0.42	0.84							
PH1/4-N1UT	1/4	NPT1/8	0.31	0.97	0.81	0.43	0.92	0.67	0.49	7/16	0.65	4.3	7.1	0.38
PH1/4-N2UT		NPT1/4	0.43	1.13	0.90	0.48	1.00							
PH5/16-N1UT	5/16	NPT1/8	0.31	0.97	0.81	0.46	1.06	0.72	0.57	7/16	0.71	6	9.9	0.54
PH5/16-N2UT		NPT1/4	0.43	1.13	0.90	0.52	1.12							
PH3/8-N2UT	3/8	NPT1/4	0.43	1.13	0.90	0.59	1.22	0.80	0.69	9/16	1.05	7	10.7	0.58
PH3/8-N3UT		NPT3/8	0.47	1.36	1.12	0.62	1.23							
PH1/2-N3UT	1/2	NPT3/8	0.47	1.36	1.12	0.68	1.45	0.92	0.83	3/4	2.29	9	20.3	1.10
PH1/2-N4UT		NPT1/2	0.59	1.62	1.30	0.74	1.43							

PX Branch Y



Appearance Dimension for Metric thread

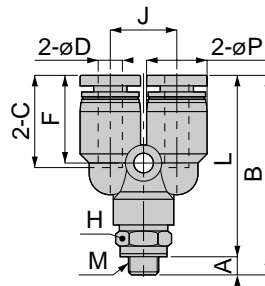

Appearance Dimension for Taper pipe thread (PT)

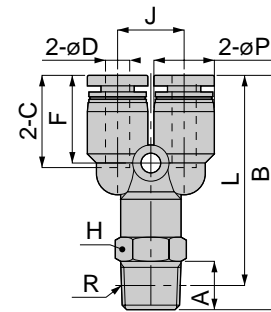

Unit: inch

Model	ØD (Tube dia.)	M/R	A	B	L	ød	C	øP	F	J	H (Hex.)	Weight (OZ)	Orifice dia. (mm)	Eff. sect. Area (mm ²)	Cv
PX4-M5T	4	M5 x 0.8	0.12	1.29	1.18	0.13	0.59	0.39	0.56	0.43	0.31	0.31	2.1	3.4	0.18
PX4-01T		R1/8	0.31	1.51	1.35						0.39	0.47		4.7	0.25
PX6-01T	6	R1/8	0.31	1.63	1.47	0.13	0.67	0.49	0.62	0.47	0.39	0.56	4	10.3	0.56
PX6-02T		R1/4	0.43	2.04	1.80			0.17	0.57	0.68	0.55	0.92		5	9.9
PX8-01T	8	R1/8	0.31	1.88	1.72	0.17	0.72	0.57	0.68	0.55	0.47	0.70	5.4	20	1.08
PX8-02T		R1/4	0.43	2.03	1.80			0.55	0.96	23.6	1.28				
PX8-03T		R3/8	0.47	2.29	2.04			0.69	0.76	0.71	0.67	1.56		7.3	36.5
PX10-02T	10	R1/4	0.43	2.22	1.98	0.17	0.80	0.69	0.77	0.71	0.55	1.23	7.5	35.9	1.95
PX10-03T		R3/8	0.47	2.30	2.05						0.67	1.68	8.3	42.5	2.30
PX12-03T	12	R3/8	0.47	2.39	2.14	0.17	0.92	0.83	0.87	0.79	0.67	1.95	8.9	45.7	2.48
PX12-04T		R1/2	0.59	2.54	2.22						0.83				

Appearance Dimension for Unified thread

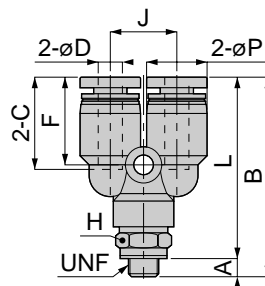

Appearance Dimension for Pipe thread general purpose (NPT)

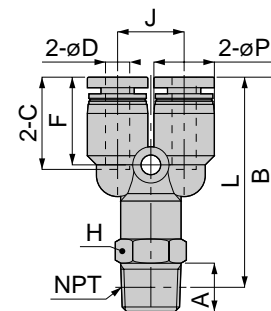

Unit: inch

Model	ØD (Tube dia.)	UNF/NPT	A	B	L	ød	C	øP	F	J	H (Hex.)	Weight (OZ)	Orifice dia. (mm)	Eff. sect. Area (mm ²)	Cv
PX5/32-U10UT	5/32	No. 10-32UNF	0.12	1.29	1.18	0.13	0.59	0.39	0.56	0.43	5/16	0.31	2.1	3.4	0.18
PX5/32-N1UT		NPT1/8	0.31	1.51	1.35						7/16	0.47		4.7	0.25
PX1/4-N1UT	1/4	NPT1/8	0.31	1.63	1.46	0.13	0.67	0.49	0.62	0.47	7/16	0.56	4	10.3	0.56
PX1/4-N2UT		NPT1/4	0.43	2.04	1.81			0.17	0.57	0.68	0.55	9/16		0.92	5
PX5/16-N1UT	5/16	NPT1/8	0.31	1.88	1.72	0.17	0.72	0.57	0.68	0.55	1/2	0.70	5.4	20	1.08
PX5/16-N2UT		NPT1/4	0.43	2.03	1.81			0.55	0.96	23.6	1.28				
PX5/16-N3UT		NPT3/8	0.47	2.29	2.05			0.69	0.76	0.71	11/16	1.56		7.3	36.5
PX3/8-N2UT	3/8	NPT1/4	0.43	2.22	1.99	0.17	0.80	0.69	0.77	0.71	9/16	1.23	7.5	35.9	1.95
PX3/8-N3UT		NPT3/8	0.47	2.30	2.06						11/16	1.68	8.3	42.5	2.30
PX1/2-N3UT	1/2	NPT3/8	0.47	2.39	2.15	0.17	0.92	0.83	0.87	0.79	11/16	1.95	8.9	45.7	2.48
PX1/2-N4UT		NPT1/2	0.59	2.54	2.22						7/8				

Tube Fitting

PY Union Y

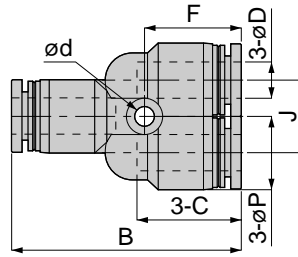

Unit: inch

Model	ØD (Tube dia.)	B	øP	C	ød	J	F	Weight (OZ)	Orifice dia. (mm)	Eff. sect. Area (mm ²)	Cv
PY4T	4	1.29	0.39	0.59	0.13	0.43	0.55	0.27	2.1	2.5	0.14
PY6T	6	1.48	0.49	0.67	0.13	0.47	0.62	0.38	4.1	8.7	0.47
PY8T	8	1.67	0.57	0.72	0.13	0.55	0.68	0.54	5.3	16.7	0.91
PY10T	10	1.91	0.69	0.80	0.17	0.71	0.77	0.89	8.1	33.1	1.79
PY12T	12	2.16	0.83	0.92	0.17	0.79	0.87	1.28	8.6	37.8	2.05

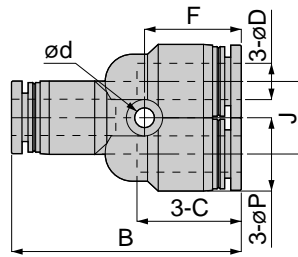

Unit: inch

Model	ØD (Tube dia.)	B	øP	C	ød	J	F	Weight (OZ)	Orifice dia. (mm)	Eff. sect. Area (mm ²)	Cv
PY5/32T	5/32	1.29	0.39	0.59	0.13	0.43	0.55	0.27	2.1	2.5	0.14
PY1/4T	1/4	1.48	0.49	0.67	0.13	0.47	0.62	0.38	4.1	8.7	0.47
PY5/16T	5/16	1.67	0.57	0.72	0.13	0.55	0.68	0.54	5.3	16.7	0.91
PY3/8T	3/8	1.91	0.69	0.80	0.17	0.71	0.77	0.89	8.1	33.1	1.79
PY1/2T	1/2	2.16	0.83	0.92	0.17	0.79	0.87	1.28	8.6	37.8	2.05

PW Different Diam. Union Y

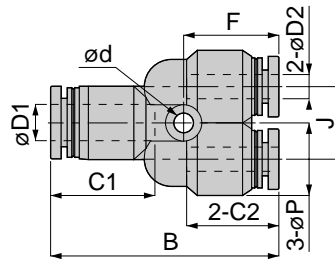

Unit: inch

Model	ØD1 (Tube dia.)	ØD2 (Tube dia.)	B	øP	C1	C2	ød	J	F	Weight (OZ)	Orifice dia. (mm)	Eff. sect. Area (mm ²)	Cv
PW6-4T	6	4	1.46	0.49	0.67	0.59	0.13	0.47	0.60	0.37	3.8	4	0.22
PW8-6T	8	6	1.67	0.57	0.72	0.67	0.13	0.55	0.68	0.51	5.8	6.3	0.34
PW10-8T	10	8	1.89	0.69	0.80	0.72	0.17	0.71	0.76	0.78	8.2	22	1.19
PW12-10T	12	10	2.15	0.83	0.92	0.80	0.17	0.79	0.87	1.22	7.9	35.9	1.95

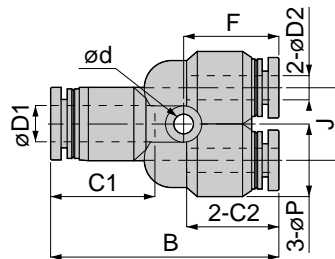

Unit: inch

Model	ØD1 (Tube dia.)	ØD2 (Tube dia.)	B	øP	C1	C2	ød	J	F	Weight (OZ)	Orifice dia. (mm)	Eff. sect. Area (mm ²)	Cv
PW1/4-5/32T	1/4	5/32	1.46	0.49	0.67	0.59	0.13	0.47	0.60	0.37	3.8	4	0.22
PW5/16-1/4T	5/16	1/4	1.67	0.57	0.72	0.67	0.13	0.55	0.68	0.51	5.8	6.3	0.34
PW3/8-5/16T	3/8	5/16	1.89	0.69	0.80	0.72	0.17	0.71	0.76	0.78	8.2	22	1.19
PW1/2-3/8T	1/2	3/8	2.15	0.83	0.92	0.80	0.17	0.79	0.87	1.22	7.9	35.9	1.95

Speed Controller

***Maintaining basic functions,
this low-cost Speed Controller achieves
high-cost performance.***

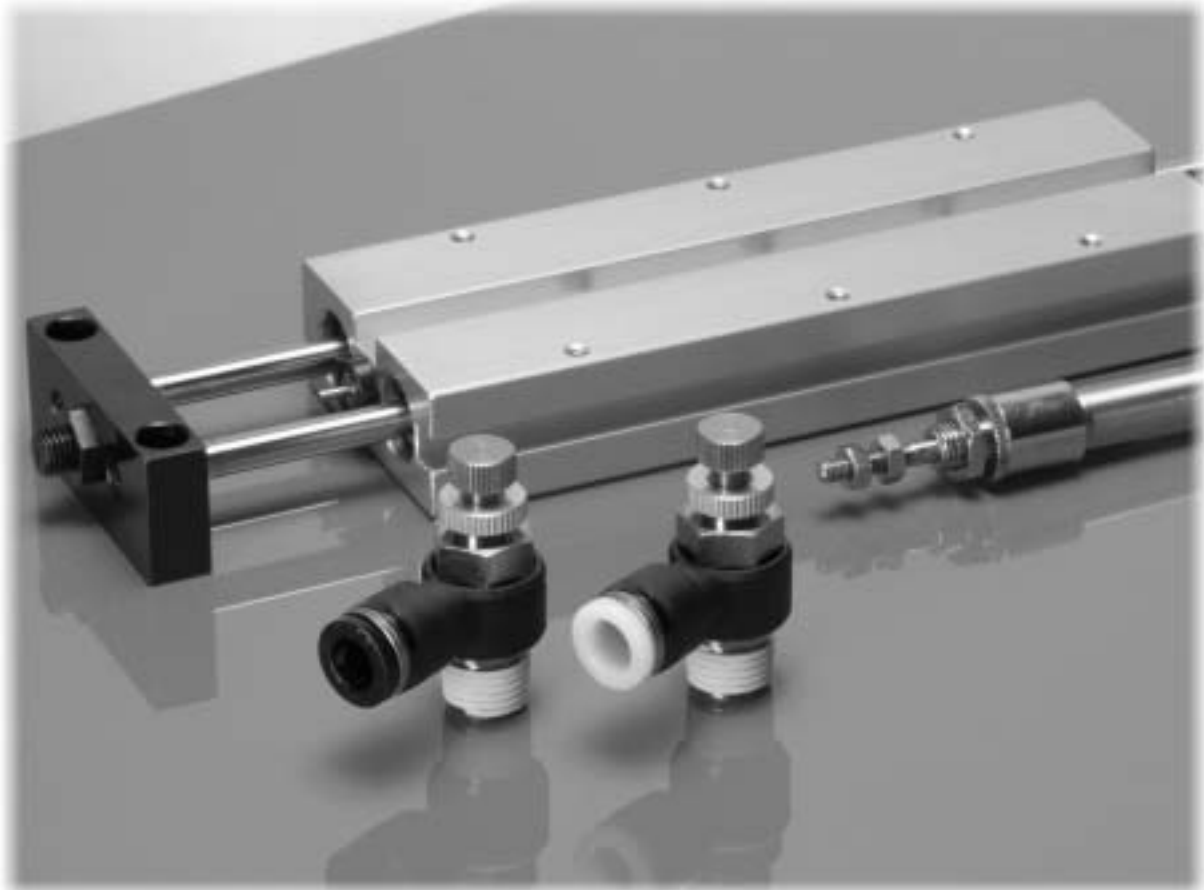

- *The Speed Controller controls the operation speed of a driving device.*
- *The lead-out directions are free thanks to rotation of the resin body and joint.*

Specifications

Fluid admitted	Air
Max. service pressure	150psi (0.9MPa)
Check valve operating pressure	7.25psi (0.05MPa)
Service temperature range	32 ~ 140°F (0 ~ 60°C)

Construction

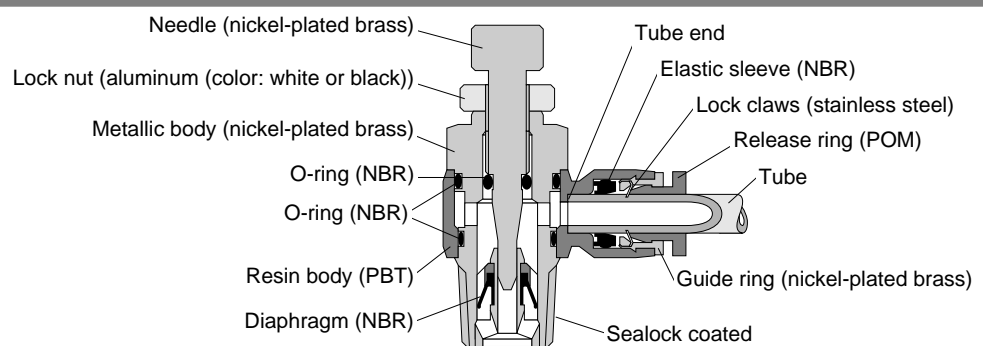
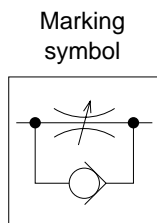

Speed Controller

Model Designation (Example)

JSC
(1) 1/4
(2) - N1
(3) A
(4) U
(5) T

(5). Hexagon flat-to-flat specification

U: Hexagon flat-to-flat inch spec. (NPT)
No code: Hexagon flat-to-flat mm spec.

(4). Control direction

A: Meter-out control (Color of lock nut: white (primary color)) (*1)

B: Meter-in control (Color of lock nut: black) (*2)

*1. Meter-out control

- The flow rate of air entering from the thread side can be controlled, whereas air entering from the joint side is not controlled.

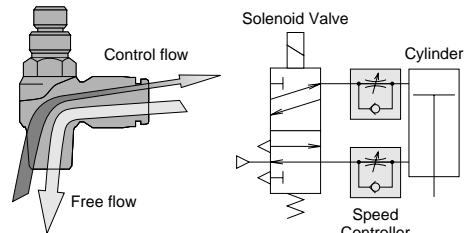

*2. Meter-in control

- The flow rate of air entering from the joint side can be controlled, whereas air entering from the thread side is not controlled.

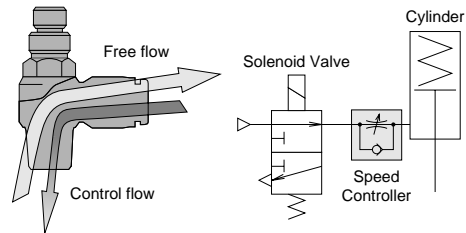

(3). Thread size (R)

	Metric thread	Taper pipe thread			
Code	M5	O1	O2	O3	O4
Size	M5 x 0.8	R1/8	R1/4	R3/8	R1/2
	Unified fine thread	American standard taper pipe thread			
Code	U10	N1	N2	N3	N4
Size	10-32UNF	NPT1/8	NPT1/4	NPT3/8	NPT1/2

(2). Tube dia. (øD)

	mm size				
Code	4	6	8	10	12
Dia. (mm)	4	6	8	10	12
	inch size				
Code	5/32	1/4	5/16	3/8	1/2
Dia. (inch)	5/32	1/4	5/16	3/8	1/2

(1). Type

Connection and Disconnection

1. How to fit and release Tubing

(1). Tube insertion

Simply insert a tubing to the end of Speed Controller. The lock claws automatically fix the tubing and the elastic sleeve seals the tube surround. Please refer to "2. Cautions on the fitting of tube" in "Common Safety Instructions for Quick-Fitting Joint" for other instructions.

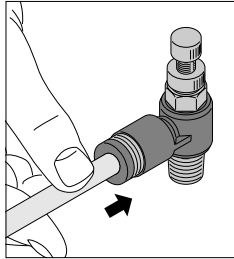

(2). Tube release

In case of releasing the tube, push the release ring. The lock claws open and the tube can be released. Before releasing the tube, make certain that the pressure inside the tube is zero.

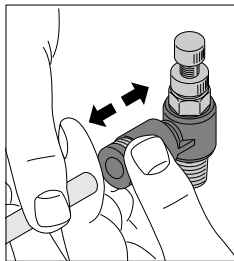

2. How to tighten the screw

Tighten the outside hexagon by a spanner. (Please refer to the text for detail.) Please refer to "Table. Recommended Tightening Torque" in "1. Notes on installation" on "Common Safety Instructions for Controllers".

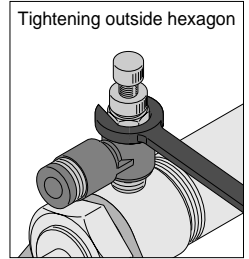

Speed Adjustment

1. How to run the driving device faster

Turn the needle counterclockwise from fully closed position, and the driving device will run faster. Tighten the Lock nut at desirable speed in order to keep same speed.

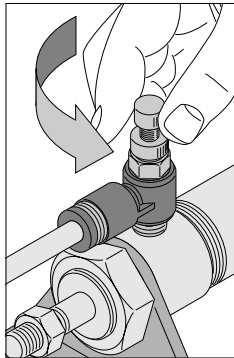

2. How to run the driving device slower

Turn the needle clockwise, and the driving device will run slower. Tighten the Lock nut at desirable speed in order to keep same speed.

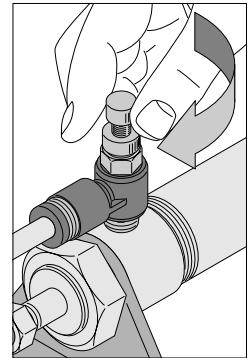

⚠ Detailed Safety Instructions

Before using the PISCO device, be sure to read the "Safety Instructions", "Common Safety Instructions for Products Listed in This Manual" on page 19 to 21 and "Common Safety Instructions for Controllers" on page 24.

Warning

1. Adjust the speed of the actuator by opening the needle gradually from the fully closed position. With the needle open, there are chances of the actuator flying out. Turn the needle clockwise to close or counterclockwise to open.
2. Do not subject the product with a rotatable resin to forcible swinging or rotation. Otherwise the body may suffer damage or develop leakage.

Caution

1. The Speed Controller is designed to tolerate some air flow at fully closed position. Therefore do not use it for applications that permits no air flow.

Speed Controller

JSC Elbow

Appearance Dimension
for Metric thread

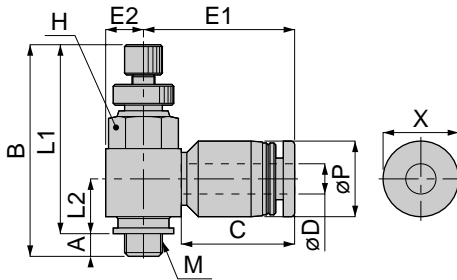

Appearance Dimension
for Taper pipe thread (PT)

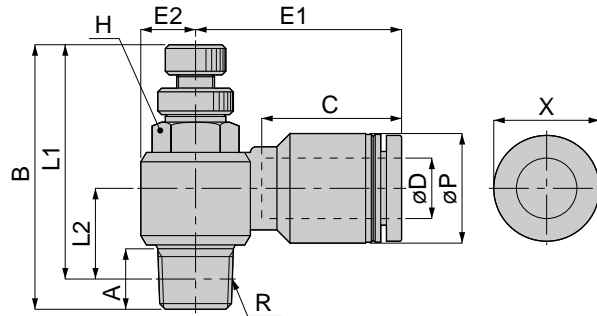

Unit: inch

Model	ØD (Tube dia.)	M/R	A	B		L1		L2	øP	C	E1	E2	H (Hex.)	X	Y	Weight (OZ)	
				max	min	max	min										
JSC4-M5 T	4	M5x0.8	0.11	1.17	1.06	1.05	0.95	0.28	0.39	0.59	0.78	0.19	0.31	0.39			0.30
JSC4-01 T		R1/8	0.31	1.60	1.35	1.44	1.20	0.42			0.84	0.28	0.39				0.63
JSC6-M5 T	6	M5x0.8	0.11	1.17	1.06	1.05	0.95	0.33	0.49	0.67	0.94	0.19	0.31	0.46			0.33
JSC6-01 T		R1/8	0.31	1.60	1.35	1.44	1.20	0.43			0.92	0.28	0.39				0.67
JSC6-02 T		R1/4	0.43	1.88	1.63	1.65	1.39	0.48			1.00	0.36	0.55				1.27
JSC8-01 T	8	R1/8	0.31	1.60	1.35	1.44	1.20	0.47	0.57	0.71	1.06	0.28	0.39	0.54			0.70
JSC8-02 T		R1/4	0.43	1.88	1.63	1.65	1.39	0.52			1.12	0.36	0.55				1.34
JSC10-02 T	10	R1/4	0.43	1.88	1.63	1.65	1.39	0.58	0.69	0.80	1.22	0.36	0.55	0.66			1.44
JSC10-03 T		R3/8	0.47	2.11	1.83	1.86	1.58	0.66			1.23	0.43	0.75				2.39
JSC12-03 T	12	R3/8	0.47	2.11	1.83	1.86	1.58	0.72	0.83	0.92	1.45	0.43	0.75	0.78			2.50
JSC12-04 T		R1/2	0.59	2.33	2.06	2.01	1.74	0.78			1.43	0.55	0.94				3.80

Appearance Dimension
for Unified thread

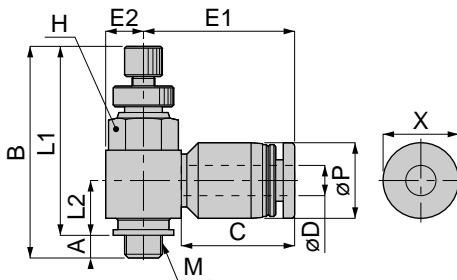

Appearance Dimension
for Pipe thread general purpose (NPT)

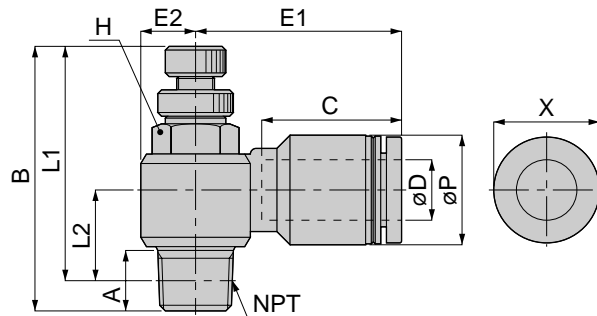

Unit: inch

Model	ØD (Tube dia.)	UNF/NPT	A	B		L1		L2	øP	C	E1	E2	H (Hex.)	X	Y	Weight (OZ)	
				max	min	max	min										
JSC5/32-U10 UT	5/32	No. 10-32UNF	0.11	1.17	1.06	1.05	0.95	0.28	0.39	0.59	0.78	0.19	5/16	0.39			0.30
JSC5/32-N1 UT		NPT1/8	0.31	1.60	1.35	1.44	1.20	0.42			0.84	0.28	7/16				0.63
JSC1/4-U10 UT	1/4	No. 10-32UNF	0.11	1.17	1.06	1.05	0.95	0.33	0.49	0.67	0.94	0.19	5/16	0.46			0.33
JSC1/4-N1 UT		NPT1/8	0.31	1.60	1.35	1.44	1.20	0.43			0.92	0.28	7/16				0.67
JSC1/4-N2 UT		NPT1/4	0.43	1.88	1.63	1.65	1.39	0.48			1.00	0.36	9/16				1.27
JSC5/16-N1 UT	5/16	NPT1/8	0.31	1.60	1.35	1.44	1.20	0.47	0.57	0.71	1.06	0.28	7/16	0.54			0.70
JSC5/16-N2 UT		NPT1/4	0.43	1.88	1.63	1.65	1.39	0.52			1.12	0.36	9/16				1.34
JSC3/8-N2 UT	3/8	NPT1/4	0.43	1.88	1.63	1.65	1.39	0.58	0.69	0.80	1.22	0.36	9/16	0.66			1.44
JSC3/8-N3 UT		NPT3/8	0.47	2.11	1.83	1.86	1.58	0.66			1.23	0.43	3/4				2.39
JSC1/2-N3 UT	1/2	NPT3/8	0.47	2.11	1.83	1.86	1.58	0.72	0.83	0.92	1.45	0.43	3/4	0.78			2.50
JSC1/2-N4 UT		NPT1/2	0.59	2.33	2.06	2.01	1.74	0.78			1.43	0.55	1				3.80

Characteristics

JSC 4-M5 T
6-M5 T
5/32-U10 UT
1/4-U10 UT

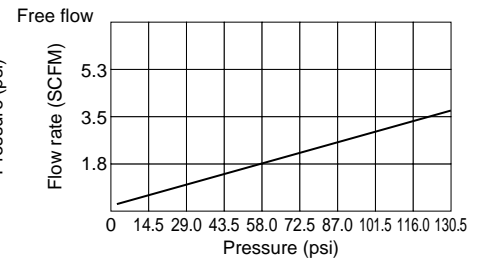
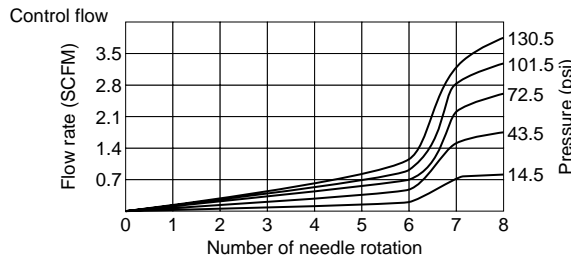

JSC 4-01 T
6-01 T
8-01 T
5/32-N1 UT
1/4-N1 UT
5/16-N1 UT

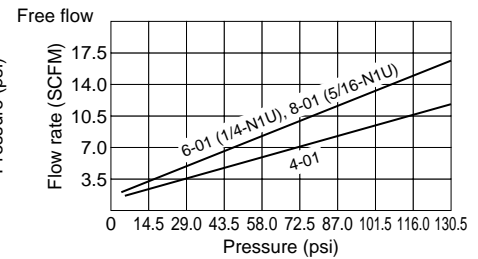
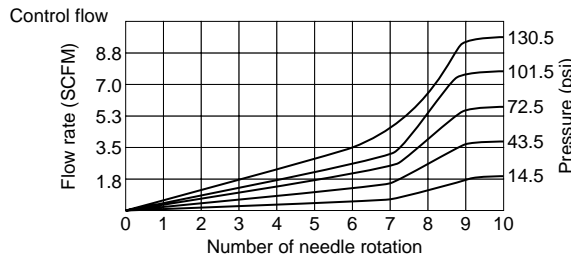

JSC 6-02 T
8-02 T
10-02 T
1/4-N2 UT
5/16-N2 UT
3/8-N2 UT

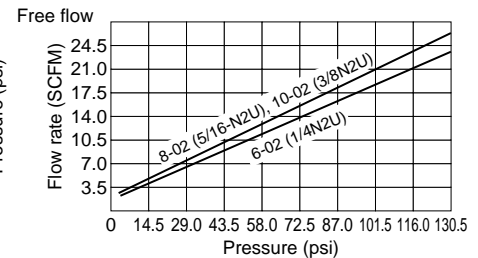
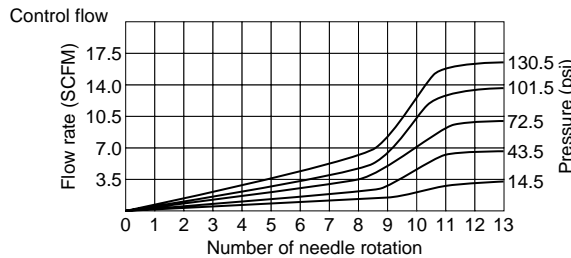

JSC 10-03 T
12-03 T
3/8-N3 UT
1/2-N3 UT

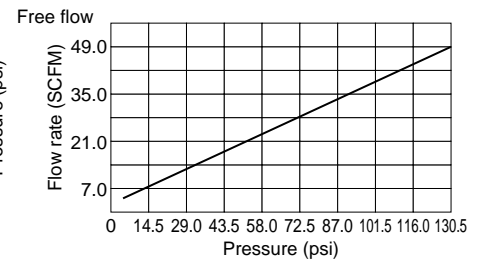
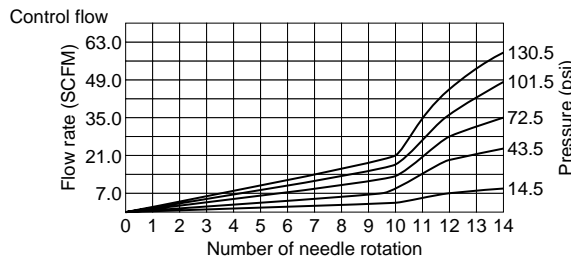

JSC 12-04 T
1/2-N4 UT

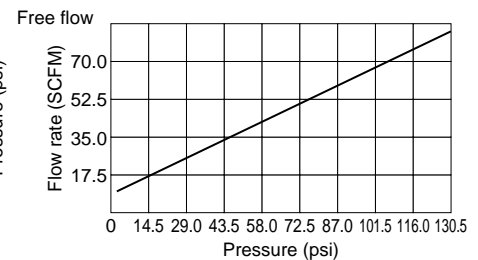
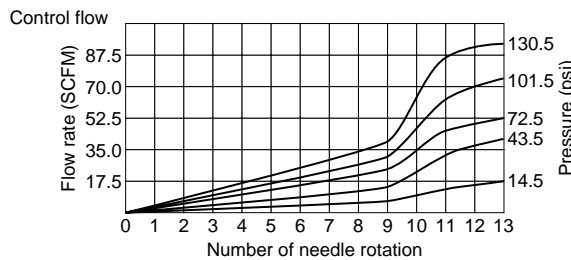

Safety Instructions

These Safety Instructions aim to prevent injuries to human bodies and damage to properties by requiring proper use of PISCO devices.

Also the relevant requirements of ISO 4414 and JIS B8370 must be observed.

ISO 4414: Pneumatic fluid power ... Recommendations for the application of equipment to transmission and control systems.

JIS B 8370: General standards for pneumatic systems

Safety instructions are classified into "Danger", "Warning" and "Caution", categories depending on the degree of danger or damage involved when the safety instructions are not complied with in handling the equipment.

Danger

Failure to heed the warning of apparent danger may result in death or serious injuries.

Warning

Failure to heed the warning of conditionally dangerous situations may result in death or serious injuries.

Caution

Failure to heed the warning of conditionally dangerous situations may result in minor or not too serious injuries or damage to properties.

*Safety Instructions are subject to change without advance notice.

Common Safety Instructions for Products Listed in This Manual

PISCO products are designed and manufactured for use with general industrial machinery and equipment. Therefore be sure to observe the following safety instructions:

Danger

1. Do not use PISCO devices with the following equipment:
 - (1) Equipment used for the sustenance or control of people's health or lives
 - (2) Equipment used for the movement or transport of people
 - (3) Equipment used specifically to ensure safety

Warning

1. Avoid the following uses for PISCO devices:
 - (1) Use under conditions not specified for the device
 - (2) Use in any outdoor environment
 - (3) Use in locations where the device is exposed to excessive vibration or shocks
 - (4) Use in locations where the device is exposed to any corrosive gas, inflammable gas, chemicals, seawater, or vapor.

*Certain PISCO devices, however, can be used in environments as described above. Therefore check on the specifications for the use of individual devices.
2. Do not disassemble or remodel the PISCO devices in such a way as may affect the basic structure, performance or function of them.
3. Carry out maintenance and checks of the PISCO devices only after turning power off, shutting air off and making certain that the pressure in the piping has dropped to zero.
4. Never touch the release ring of the Quick-Fitting Joint when there is pressure working on it. Touching may release the ring, which in turn may cause the tube to fall out.
5. Avoid too frequent switching of air pressure. Otherwise the device body may heat up to cause burns on you.
6. Do not allow tension, twist or bending forces to act on the joints. Undue forces may damage the joint body.
7. For applications in which the threaded side or the tube connection side is subject to vibration, use Rotary Joints, High Rotary Joints or Multi-Circuit Rotary Blocks only. Swinging or rotation may damage the joint body.
8. For applications with hot water of 60 or above or thermal oil, use no other joints than Die Temperature Control Fitting. Heat or hydolysis may damage the joint body.
9. For applications in which the scattering of static electricity or charging must be prevented, use no other joints than EG Joints. Static electricity may cause system malfunction or trouble.
10. Never use joint other than Spatter Joint or Brass Joint where they are exposed to spatter. Otherwise can cause fire.

Caution

1. In installing the piping, be sure to remove dust or drainage from within the piping. Dust or drainage left unremoved may enter other equipment, thus causing troubles.
2. When using an ultrasoft tube to connect to a Quick-Fitting Joint, be sure to use an insert ring in the bore of the tube. Otherwise the tube may fall out to cause leakage.
3. When you use tubes of brands other than ours, be sure to confirm that the outside diameter of the tubes satisfies the tolerance specified Table 1.

Table 1. Tube O.D. Tolerance

mm size	Nylon tube	Urethane tube	inch size	Nylon tube	Urethane tube
ø3mm	—	±0.15mm	ø1/8	±0.0039in.	±0.0059in.
ø4mm	±0.1mm	±0.15mm	ø5/32	+0.0039in. -0.002in.	+0.0059in. -0.0039in.
ø6mm	±0.1mm	±0.15mm	ø3/16	±0.0039in.	±0.0059in.
ø8mm	±0.1mm	±0.15mm	ø1/4	±0.0039in.	±0.0059in.
ø10mm	±0.1mm	±0.15mm	ø5/16	+0.0059in. 0	+0.0079in. -0.002in.
ø12mm	±0.1mm	±0.15mm	ø3/8	±0.0039in.	±0.0059in.
ø16mm	±0.1mm	±0.15mm	ø1/2	±0.0039in.	±0.0059in.
			ø5/8	+0.0039in. 0	+0.0079in. -0.002in.

Common Safety Instructions for Products Listed in This Manual

4. Cautions on the fitting of tube

- (1) Make certain that the end of the tube is cut at right angles, the tube surface is free from flaws, and the tube is not deformed into an ellipse.
- (2) When fitting a tube, refer to the dimensional specification of Table 2. To prevent leaks, insert the tube to end (C) completely.

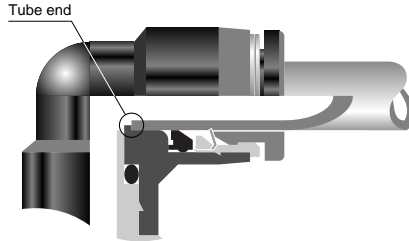

- (3) On completion of fitting, make certain that the tube does not come out at your pulling.

5. Cautions on the release of tube

- (1) Before releasing the tube, make certain that the pressure inside the tube is zero.
- (2) Push the release ring fully inside and pull out the tube. Unless you push it completely in, the tube may not come out and scrapings of tube may be left inside the joint.

6. Cautions on the installation of joint body

- (1) When installing the joint body, tighten it with a proper tool, using the outside or inside hexagon.
- (2) In tightening the screw, use the tightening torque recommended in Table 2.
 - Use of a torque higher than the recommended level may damage thread or deform gasket, thus causing leaks.
 - Use of a torque lower than the recommended level may cause loose screw and leakage.
- (3) With the joint whose piping direction will not change after tightening, make adjustment within the recommended range of tightening torques.

Table 2. Tightening Torque, Sealock Color and Gasket Material

Thread type	Thread size	Tightening torque	Sealock color	Gasket material
Metric thread	M3×0.5	0.7N·m (0.52lbf-ft)	—	SUS304, NBR
	M5×0.8	1.0~1.5N·m (0.74~1.11lbf-ft)		
	M6×1.0	1.8~2.3N·m (1.33~1.70lbf-ft)		
	M6×0.75	0.8~1N·m (0.59~0.74lbf-ft)		POM (Polyacetal)
	M8×0.75	1.0~2.0N·m (0.74~1.48lbf-ft)		
	M5×0.8	1.0~1.5N·m (0.74~1.11lbf-ft)		
Taper pipe thread	R1/8	7~9N·m (5.16~6.64lbf-ft)	White	—
	R1/4	12~14N·m (8.85~10.33lbf-ft)		
	R3/8	22~24N·m (16.23~17.70lbf-ft)		
	R1/2	28~30N·m (20.65~22.13lbf-ft)		
Unified thread	No.10-32UNF	1.0~1.5N·m (0.74~1.11lbf-ft)	—	SUS304, NBR
Pipe thread General purpose (inch)	1/16-28NPT	7~9N·m (5.16~6.64lbf-ft)	Gray	—
	1/8-27NPT	7~9N·m (5.16~6.64lbf-ft)		
	1/4-18NPT	12~14N·m (8.85~10.33lbf-ft)		
	3/8-18NPT	22~24N·m (16.23~17.70lbf-ft)		
	1/2-14NPT	28~30N·m (20.65~22.13lbf-ft)		

7. Cautions on the removal of joint body

- (1) When removing the joint body, loosen it with a proper tool, using the outside or inside hexagon.
- (2) Remove sealant sticking to the thread on the mating equipment. The sealant left sticking may enter the peripheral equipment and cause trouble.

⚠ Common Safety Instructions for Quick-Fitting Joint

Be sure to read the following instructions before selecting and using the PISCO devices. Also read the detailed instructions for individual series.

⚠ Warning

1. Never use the Quick-Fitting Joint with fluids other than air or water (usable with some models). For applications with fluids other than air or water, contact PISCO for instructions.
2. Never use joints other than Spatter Joint or Brass Joint where they are exposed to spatter. Otherwise spatter can cause fire.
3. For applications in which the threaded side or the tube connection side is subject to vibration or rotation, use Rotary Joints, High Rotary Joints or Multi-Circuit Rotary Blocks only. Swinging or rotation may damage the joint body.
4. For applications with hot water of 60 (140) or above or thermal oil, use no other joints than Die Temperature Control Fittings. Heat or hydrolysis may damage the joint body.
5. For applications in which the scattering of static electricity or charging must be prevented, use no other joints than EG Joints. Static electricity may cause system malfunction or trouble.
6. Do not allow tension, twist or bending forces to act on the joints. Undue forces may damage the joint body.

⚠ Caution

1. When you use tubes of brands other than ours, be sure to confirm that the outside diameter of the tubes satisfies the tolerance specified in Table 1.

Table 1. Tube O.D. Tolerance

mm size	Nylon tube	Urethane tube	inch size	Nylon tube	Urethane tube
ø3mm	—	±0.15mm	ø1/8	± 0.0039in.	± 0.0059in.
ø4mm	±0.1mm	±0.15mm	ø5/32	+ 0.0039in. - 0.002in.	+ 0.0059in. - 0.0039in.
ø6mm	±0.1mm	±0.15mm	ø3/16	± 0.0039in.	± 0.0059in.
ø8mm	±0.1mm	±0.15mm	ø1/4	± 0.0039in.	± 0.0059in.
ø10mm	±0.1mm	±0.15mm	ø5/16	+ 0.0059in. 0	+ 0.0079in. - 0.002in.
ø12mm	±0.1mm	±0.15mm	ø3/8	± 0.0039in.	± 0.0059in.
ø16mm	±0.1mm	±0.15mm	ø1/2	± 0.0039in.	± 0.0059in.
			ø5/8	+ 0.0039in. 0	+ 0.0079in. - 0.002in.

2. Cautions on the fitting of tube

- (1) Make certain that the end of the tube is cut at right angles, the tube surface is free from flaws, and the tube is not deformed into an ellipse.
- (2) When fitting a tube, refer to the dimensional specification of Table 2. To prevent leaks, insert the tube to end (C) completely.
- (3) On completion of fitting, make certain that the tube does not come out at your pulling.

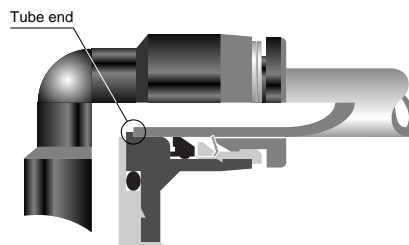

3. Cautions on the release of tube

- (1) Before releasing the tube, make certain that the pressure inside the tube is zero.
- (2) Push the release ring fully inside and pull out the tube. Unless you push it completely in, the tube may not come out and scrapings of tube may be left inside the joint.

Common Safety Instructions for Quick-Fitting Joint

4. Cautions on the installation of joint body

- (1) When installing the joint body, tighten it with a proper tool, using the outside or inside hexagon.
- (2) In tightening the screw, use the tightening torque recommended in Table 2.
 - Use of a torque higher than the recommended level may damage thread or deform gasket, thus causing leaks.
 - Use of a torque lower than the recommended level may cause loose screw and leakage.
- (3) With the joint whose piping direction will not change after tightening, make adjustment within the recommended range of tightening torques.

Table 2. Tightening Torque, Sealock Color and Gasket Material

Thread type	Thread size	Tightening torque	Sealock color	Gasket material
Metric thread	M3×0.5	0.7N·m (0.52lbf·ft)	—	SUS304, NBR
	M5×0.8	1.0~1.5N·m (0.74~1.11lbf·ft)		
	M6×1.0	1.8~2.3N·m (1.33~1.70lbf·ft)		POM (Polyacetal)
	M6×0.75	0.8~1N·m (0.59~0.74lbf·ft)		
	M8×0.75	1.0~2.0N·m (0.74~1.48lbf·ft)		
	M5×0.8	1.0~1.5N·m (0.74~1.11lbf·ft)		
Taper pipe thread	R1/8	7~9N·m (5.16~6.64lbf·ft)	White	—
	R1/4	12~14N·m (8.85~10.33lbf·ft)		
	R3/8	22~24N·m (16.23~17.70lbf·ft)		
	R1/2	28~30N·m (20.65~22.13lbf·ft)		
Unified thread	No.10-32UNF	1.0~1.5N·m (0.74~1.11lbf·ft)	—	SUS304, NBR
Pipe thread General purpose (inch)	1/16-28NPT	7~9N·m (5.16~6.64lbf·ft)	Gray	—
	1/8-27NPT	7~9N·m (5.16~6.64lbf·ft)		
	1/4-18NPT	12~14N·m (8.85~10.33lbf·ft)		
	3/8-18NPT	22~24N·m (16.23~17.70lbf·ft)		
	1/2-14NPT	28~30N·m (20.65~22.13lbf·ft)		

5. Cautions on the removal of joint body

- (1) When removing the joint body, loose it with a proper tool, using the outside or inside hexagon.
- (2) Remove sealant sticking to the thread on the mating equipment. The sealant left sticking may enter the peripheral equipment and cause trouble.

Common Safety Instructions for Controllers

Be sure to read the following instructions before selecting and using the PISCO devices. Also read the detailed instructions for individual series.

Warning

1. Each device has its control direction, so check it is manual and by the mark on the device before use. Mistaking the control direction may cause injuries on the operator or damage to the equipment.
2. Do not give tension, twist or bending to the controllers. Also, do not drop or give excessive shocks to them. Such careless handling can inflict damage to them.
3. When the controller has a lock nut on it, tighten it by hand without using a tool. Tightening with a tool may damage the lock nut or the controller body. Also, incomplete may lead to a loose lock nut, which in turn may render the initial setting useless.
4. Use clean air as the pressure source. Dust or sludge may upset the control setting.

Caution

1. Notes on installation
 - (1) Tighten with a proper tool, using hexagonal or knurled part.
 - (2) In tightening the screw, use the tightening torque recommended in the following table. Use of a torque higher than the recommended level may damage thread or deform gasket, thus causing leaks. Use of a torque lower than the recommended level may cause loose screw and leakage.

Table. Recommended Tightening Torque

Hexagonal part			Knurled part		
Thread Type	Thread size	Tightening torque	Thread Type	Thread size	Tightening torque
Metric thread	M3×0.5	0.7N·m (0.52lbf.ft)	Metric thread	M5×0.8	1/6 turn after hand-tightening
	M5×0.8	1.0 ~ 1.5N·m (0.74 ~ 1.11lbf.ft)		M6×1.0	
	M6×1.0	1.8 ~ 2.3N·m (1.33 ~ 1.70lbf.ft)		M10×1.0	
Taper pipe thread	R1/8	7 ~ 9N·m (5.16 ~ 6.64lbf.ft)	Parallel pipe thread	G1/8	1/2 ~ 1 turn after hand-tightening
	R1/4	12 ~ 14N·m (8.85 ~ 10.33lbf.ft)		G1/4	
	R3/8	22 ~ 24N·m (16.23 ~ 17.70lbf.ft)			
	R1/2	28 ~ 30N·m (20.65 ~ 22.13lbf.ft)			
Unified fine thread	No.10 ~ 32UNF	1.5 ~ 1.9N·m (1.11 ~ 1.40lbf.ft)			
	1/16 ~ 28NPT	7 ~ 9N·m (5.16 ~ 6.64lbf.ft)			
Pipe thread general purpose (INCH)	1/8 ~ 27NPT	7 ~ 9N·m (5.16 ~ 6.64lbf.ft)			
	1/4 ~ 18NPT	12 ~ 14N·m (8.85 ~ 10.33lbf.ft)			
	3/8 ~ 18NPT	22 ~ 24N·m (16.23 ~ 17.70lbf.ft)			
	1/2 ~ 14NPT	28 ~ 30N·m (20.65 ~ 22.13lbf.ft)			
Parallel pipe thread	G3/8	1/2 ~ 1 turn after hand-tightening			
	G1/2				

2. Notes on removal

- (1) Loosen it with a proper tool, using the hexagonal or knurled part.
- (2) Remove sealant sticking to the thread on the mated equipment. The sealant left sticking may enter the peripheral equipment and cause trouble.

Thread and Tube Size Full Scale Chart

If you do not know exact size of your equipment, confirm it by using reference table below.

Taper pipe thread & Pipe thread general purpose (inch)

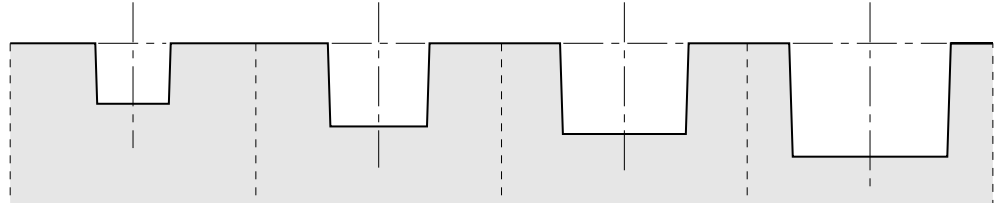

Taper pipe thread	Size	R (PT)1/8	R (PT)1/4	R (PT)3/8	R (PT)1/2
	Code	01	02	03	04
Pipe thread general purpose (inch)	Size	NPT1/8	NPT1/4	NPT3/8	NPT1/2
	Code	N1	N2	N3	N4

Metric thread & Unified thread

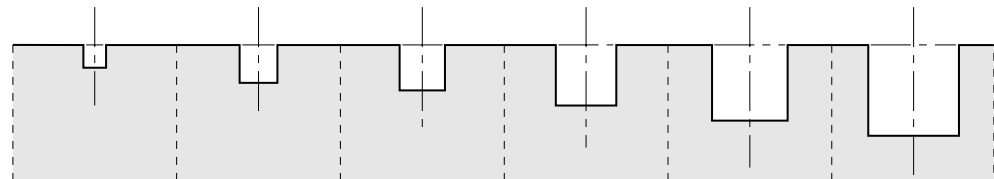

Metric thread	Size	M3 x 0.5	M5 x 0.8	M6 x 1.0	M8 x 0.75	M10 x 1.0	M12 x 1.0
	Code	M3	M5	M6	M8	—	—
Unified thread	Size	—	No.10-32UNF	—	—	—	—
	Code	—	U10	—	—	—	—

Tube diameter (mm size & inch size)

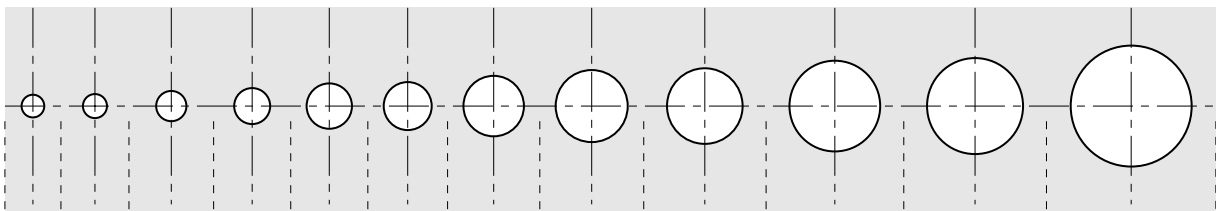

mm size	3	4	6	8	10	12	16	
inch size	1/8	5/32	3/16	1/4	5/16	3/8	1/2	5/8

