

### AIR PRESSURE SWITCH

#### General Descriptions

A compact fully adjustable pneumatically operated 316 Stainless Steel pressure switch with operating pressures up to 16 bar (232 psi).

For use on failsafe systems.

- Compact / Lightweight.
- 5 pressure ratings.
- Integrated tagging facility.
- Fluoroelastomer seals.
- 3/2 and 5/2 versions.

#### Operating Medium

#### Gases

Filtered lubricated or non-lubricated air, inert gas, sweet (natural) gases. Sour gas option available. *(details on application)*

#### Functional Symbols

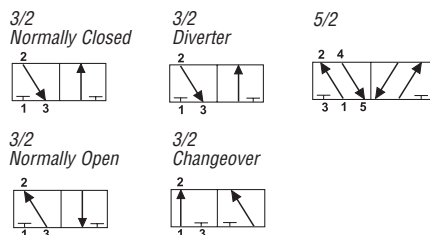

#### Technical Data

##### Ports

- 1/4"NPT (BSP option available)
- 1/8"NPT Pilot port

##### Cv (Kv)

- 3/2 valves 0.5 (7.5)
- 5/2 valves 0.7 (10.5)

##### Working Pressure

- For main directional valve 12 bar (174 psi)

##### Maximum Pilot Pressure Inlet

- 16 bar (232 psi)

##### Regulated Pressure (adjustable)

- For main directional valve
- 1.0 to 2.0 bar (14.5 to 29 psi)
- 1.0 to 4.0 bar (14.5 to 58 psi)
- 1.0 to 7.0 bar (14.5 to 102 psi)
- 1.0 to 10 bar (14.5 to 145 psi)
- 1.0 to 16 bar (14.5 to 232 psi)
- (Note 16 bar regulated pressure must be fed from independent supply to main directional valve)

##### Working Temperature

- -20°C to +80°C (-4°F to +176°F)

##### Maximum Flow

- 6 bar (87 psi), 1 bar (14.5 psi) differential
- 3/2 valves - 480 L/min (17 SCFM)
- 5/2 valves - 680 L/min (24 SCFM)

##### Pressure Setting Hysteresis

- 0.25 bar (3.63 psi)



#### Construction Materials

- Stainless steel AISI 316L to NACE MR-0175 Body
- Stainless steel AISI 316L to NACE MR-0175 Spool
- 316 Stainless Steel Springs
- Fluoroelastomer Seals
- Fluoroelastomer Diaphragm

#### Function

##### APPLICATION FOR SPRING RETURN ACTUATORS 3/2

1) Airfail stay put For this application port 3 is plugged. When pilot air is applied to port 1 or 2 in the Normally Closed mode and pilot air is greater than set pressure, air can flow in either direction. When pilot pressure falls below set pressure, the integral spool valve closes therefore block port 1 to 2 and the output from 2 remains blocked, leaving the actuator or downstream signal in the last controlled position. 2) Venting By not plugging port 3 the valve can be used in the Normally Open, Closed, Diverter or Changeover mode and the actuator will vent to atmosphere.

##### APPLICATION FOR DOUBLE ACTING ACTUATORS 5/2

1) Airfail open or close For this application when air is applied to ports 1 and 3 (N/C) or 1 and 5 (N/O) and the actuator is connected to the outlets 2 and 4 and pilot air is greater than set pressure, air from another 5/2 solenoid or air operated valve will control the double acting actuator. The pressure switch can be piped Normally Closed or Normally Open and can detect air falling below the set pressure to either open or close the actuator, via a volume tank.

### AIR PRESSURE SWITCH

Model Number	Ports P		Weight kg (lbs)	Symbol
2PS3SV022	1/4" NPT	3/2 Adjustable pressure switch 2 bar (29 psi)	1.60 (3.53)	
2PS3SV042	1/4" NPT	3/2 Adjustable pressure switch 4 bar (58 psi)	1.60 (3.53)	
2PS3SV072	1/4" NPT	3/2 Adjustable pressure switch 7 bar (102 psi)	1.60 (3.53)	
2PS3SV102	1/4" NPT	3/2 Adjustable pressure switch 10 bar (145 psi)	1.60 (3.53)	
2PS3SV162	1/4" NPT	3/2 Adjustable pressure switch 16 bar (232 psi)	1.60 (3.53)	
2PS5SV022	1/4" NPT	5/2 Adjustable pressure switch 2 bar (29 psi)	2.05 (4.52)	
2PS5SV042	1/4" NPT	5/2 Adjustable pressure switch 4 bar (58 psi)	2.05 (4.52)	
2PS5SV072	1/4" NPT	5/2 Adjustable pressure switch 7 bar (102 psi)	2.05 (4.52)	
2PS5SV102	1/4" NPT	5/2 Adjustable pressure switch 10 bar (145 psi)	2.05 (4.52)	
2PS5SV162	1/4" NPT	5/2 Adjustable pressure switch 16 bar (232 psi)	2.05 (4.52)	

### INSTALLATION DIMENSIONS mm (inches)

#### 3/2 Pressure Switch

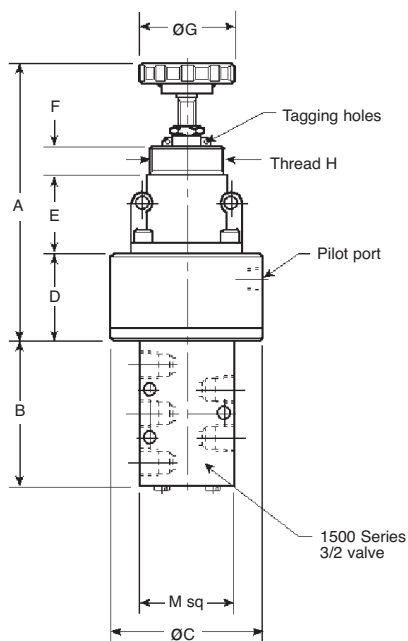

#### 5/2 Pressure Switch

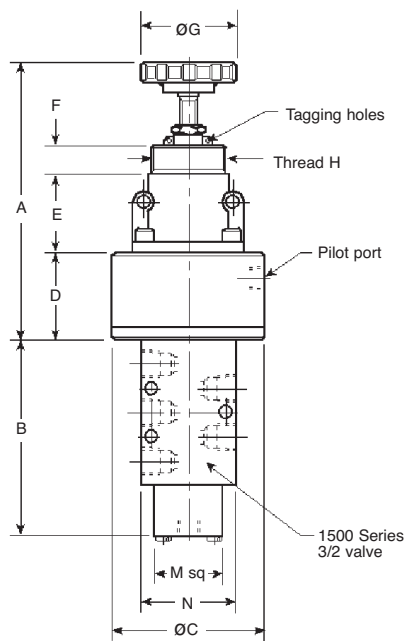

For basic dimensions of 3/2 and 5/2 valves see pg 1500.7 (Spring Return Bases)

Model Number	A	B	C	D	E	F	G	H	M	N
2PS3SV**2	127.5(5.02)	54(2.13)	70(2.76)	40(1.57)	36(1.42)	13(0.51)	44(1.73)	M34X1.5	32(1.26)	-
2PS5SV**2	127.5(5.02)	93(3.66)	70(2.76)	40(1.57)	36(1.42)	13(0.51)	44(1.73)	M34X1.5	32(1.26)	45(1.77)

### ACCESSORIES

#### Tamper Proof Cap Kit

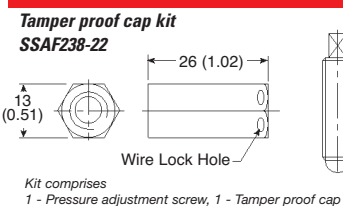

#### Panel Mounting Kit

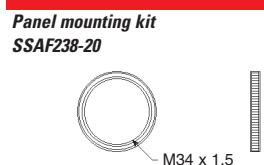

#### Mounting Bracket

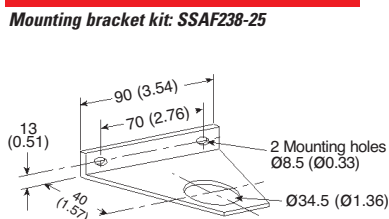

Kit comprises  
1 - Bracket 1 - Panel nut

# 4500 Ancillary Valves

1/4", 3/8", 1/2", 3/4", 1", NPT (BSP)

4500 SERIES

4500 ACCESSORIES

## UNI-DIRECTIONAL FLOW REGULATORS • BI-DIRECTIONAL FLOW REGULATORS

### General Description

#### Uni-directional

316 Stainless Steel in-line flow regulators for uni-directional operation (free flow return).

#### Bi-directional

316 Stainless Steel in-line flow regulators for bi-directional operation (separate flow control in each direction).

### Operating Medium

#### Gases

Filtered lubricated or non-lubricated air, inert gas, sweet (natural) gases. Sour gas option available. (details on application)

#### Liquids

Low pressure hydraulic, mineral oil or water.

### Functional Symbols

Uni-directional

Bi-directional

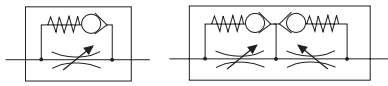

### Technical Data

#### Working Pressure

- 10 bar (145 psi)

#### Working Temperature

- -20°C to +70°C (-4°F to +158°F)

#### Low temperature version

- -50°C (-58°F) (optional)

#### Maximum Flow L/min (SCFM) Cv(Kv)

- 6 bar (87 psi), 1 bar (14.5 psi) differential

#### Uni-directional

- 1/4" 1000(35) -1.0(15.5)
- 3/8" 1680(59) -1.7(26)
- 1/2" 2520(89) -2.5(39)
- 3/4" 5428(192) -5.4(84)
- 1" 9820(347) -9.8(152)

#### Bi-directional

- 1/4" 620(22) -0.6(9.6)
- 3/8" 1290(45) -1.3(20)
- 1/2" 2000(71) -2.0(31)



### Construction Materials

- Stainless Steel AISI 316L to NACE MR-01-75 Body
- Stainless Steel AISI 316L to NACE MR-01-75 Internals
- 316 Stainless Steel Springs
- Nitrile Seals

## MODEL CODES, INSTALLATION DIMENSIONS mm (inches) and WEIGHT kg (lbs)

### Uni-Directional Flow Regulators

2REGSN122 (1/4")  
3REGSN122 (3/8")  
4REGSN122 (1/2")

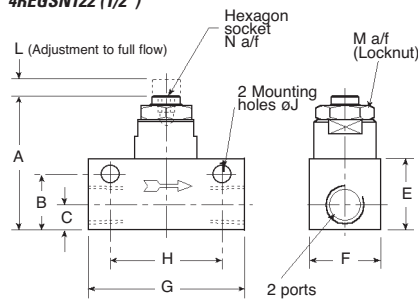

6REGSN122 (3/4")  
8REGSN122 (1")

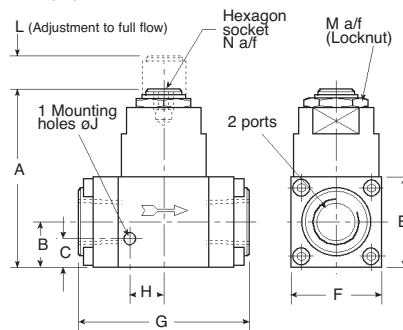

### Bi-Directional Flow Regulators

2BIDSN122 (1/4")  
3BIDSN122 (3/8")  
4BIDSN122 (1/2")

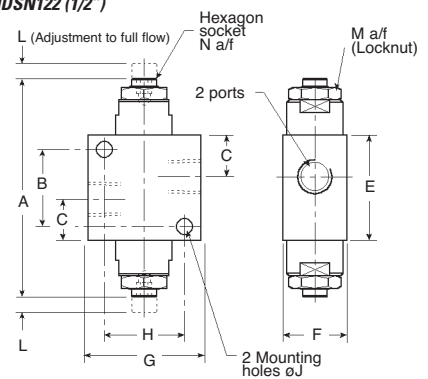

Model Number	Ports	A	B	C	E	F	G	H	J	L	M	N	WEIGHT
<b>Uni-Directional</b>													
2REGSN122	1/4" NPT	48(1.89)	20(0.79)	9(0.35)	25.4(1.00)	25.4(1.00)	56(2.20)	40(1.57)	6.35(0.25)	6(0.24)	18(0.71)	5(0.20)	0.26(0.57)
3REGSN122	3/8" NPT	70(2.76)	29(1.14)	14.5(0.57)	35(1.38)	35(1.38)	76(2.99)	45(1.77)	6.35(0.25)	12(0.47)	23.3(0.92)	6(0.24)	0.75(1.65)
4REGSN122	1/2" NPT	70(2.76)	29(1.14)	13.5(0.57)	35(1.38)	35(1.38)	76(2.99)	45(1.77)	6.35(0.25)	12(0.47)	23.3(0.92)	6(0.24)	0.75(1.65)
6REGSN122	3/4" NPT	100(3.94)	16(0.63)	25.4(1.00)	50.8(2.00)	50.8(2.00)	95(3.74)	19(0.75)	6.35(0.25)	19(0.75)	30.5(1.20)	10(0.39)	1.75(3.86)
8REGSN122	1" NPT	125(4.92)	19(0.75)	31.75(1.25)	63.5(2.50)	63.5(2.50)	95(3.74)	24(0.94)	6.35(0.25)	19(0.75)	36(1.42)	12(0.47)	2.75(6.06)
<b>Bi-Directional</b>													
2BIDSN122	1/4" NPT	85(3.35)	28(1.10)	15.5(0.61)	40(1.57)	25.4(1.00)	44.5(1.75)	32(1.26)	6.35(0.25)	6(0.24)	18(0.71)	5(0.20)	0.43(0.95)
3BIDSN122	3/8" NPT	121(4.76)	35(1.38)	21(0.83)	51(2.00)	35(1.38)	63.5(2.50)	45(1.77)	6.35(0.25)	12(0.47)	23.3(0.92)	6(0.24)	1.40(3.09)
4BIDSN122	1/2" NPT	121(4.76)	35(1.38)	21(0.83)	51(2.00)	35(1.38)	63.5(2.50)	45(1.77)	6.35(0.25)	12(0.47)	23.3(0.92)	6(0.24)	1.40(3.09)

## NEEDLE VALVES • EXHAUST PORT FLOW REGULATORS

### General Description

#### Needle Valve

316 Stainless Steel Needle Valve with 3mm or 6mm orifice.

#### Exhaust Port Flow Regulators

316 Stainless Steel exhaust flow regulator/breather supplied complete with tamper proof cap.

### Operating Medium

#### Gases

Filtered non-lubricated air, inert, sweet (natural) gases.

### Functional Symbols

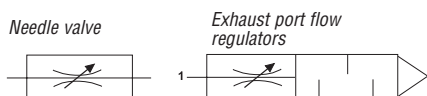

### Technical Data

#### Working Pressure

- 12 bar (145 psi) maximum

#### Working Temperature

- -20°C to +70°C (-4°F to +158°F)

#### Low temperature version

- -50°C (-58°F) (optional)

#### Maximum Flow L/min (SCFM) - Cv (Kv)

- 6 bar (87 psi), 1 bar (14.5 psi) differential

#### Needle Valve (3mm orifice)

- 1/4" 290(10.5) -0.30(4.6)

#### Needle Valve (6mm orifice)

- 1/4" 640(23) -0.64(10)

#### Exhaust Port Flow Regulators

- 1/4" 646(23) -0.65(10)

- 3/8" 1100(39) -1.10(17)

- 1/2" 1800(64) -1.80(28)

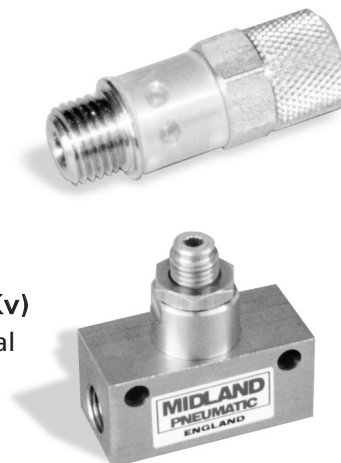

### Construction Materials

- Stainless Steel AISI 316L to NACE MR-01-75 Body
- Stainless Steel AISI 316L to NACE MR-01-75 Internals
- 316 Stainless Steel Spring
- Nitrile Seals

## MODEL CODES, INSTALLATION DIMENSIONS mm (inches) and WEIGHT kg (lbs)

### Needle Valve

- 2NDVSN12203 (1/4"-3mm orifice)
- 2NDVSN12206 (1/4"-6mm orifice)

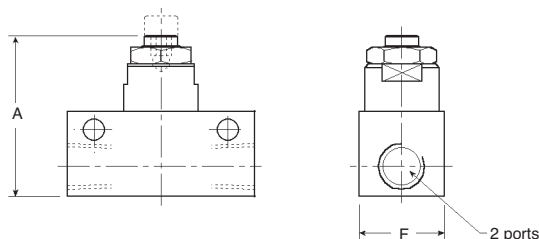

All dimensions as for uni-directional flow regulators  
Model 2REGSN122 on page 4500.3

Model Number	Ports	A	F	Weight
2NDVSN12203	1/4" NPT	48	25.4	0.26
		(1.89)	(1.00)	(0.57)
2NDVSN12206	1/4" NPT	48	25.4	0.26
		(1.89)	(1.00)	(0.57)

### Exhaust Port Flow Regulators

- 2EFRSN102 (1/4")
- 3EFRSN102 (3/8")
- 4EFRSN102 (1/2")

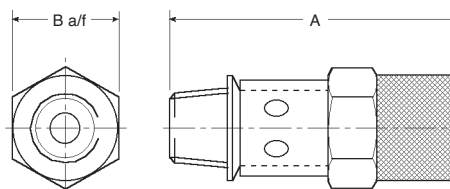

All units have 0.4mm (0.016") diameter minimum orifice to eliminate complete shut off. Units supplied complete with tamper proof cap.

Model Number	Thread	A	B	Weight
2EFRSN102	1/4" NPT	47.5	17	0.05
		(1.87)	(0.67)	(0.11)
3EFRSN102	3/8" NPT	66	23.4	0.15
		(2.60)	(0.92)	(0.33)
4EFRSN102	1/2" NPT	87.5	23.4	0.20
		(3.44)	(0.92)	(0.44)

### NON RETURN VALVES

#### General Descriptions

##### Non Return Valves

316 Stainless Steel non return valves in two ranges - one for pressures up to 12 bar (174psi) and one for pressures up to 25 bar (362 psi).

#### Operating Medium

##### Gases

Filtered lubricated or non lubricated air, inert gas, sweet (natural) gases.

Sour gas option available.

*(details on application)*

##### Liquids

Low pressure hydraulic, mineral oil or water.

#### Functional Symbols

Non return valves

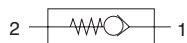

#### Technical Data

##### Working Pressure (gases & liquids)

- 12 bar (174 psi)
- 25 bar (362 psi)

##### Minimum Opening Pressure

- 0.2 bar (2.90 psi)

##### Working Temperature

- -20°C to +70°C (-4°F to +158°F)

##### Low temperature version

- -50°C (-58°F) (optional)

##### Maximum Flow L/min (SCFM) - Cv(Kv)

- 6 bar (87 psi), 1 bar (14.5 psi) differential

##### Non return valves (12 bar)

- 1/4" 1600(57) 1.6(25)
- 3/8" 2200(80) 2.3(35)
- 1/2" 3800(137) 3.9(60)
- 3/4" 5800(205) 5.8(90)
- 1" 7700(274) 7.8(120)

##### Non return valves (25 bar)

- 1/4" 736(26) 0.74(11.4)
- 3/8" 1840(65) 1.85(28.5)
- 1/2" 2600(91) 2.60(40)



#### Construction Materials

- Stainless Steel AISI 316L to NACE MR-01-75 Body
- Stainless Steel AISI 316L to NACE MR-01-75 Internals
- Acetal poppet
- 316 Stainless Steel Spring
- Nitrile Seals

### MODEL CODES, INSTALLATION DIMENSIONS mm (inches) and WEIGHT kg (lbs)

#### Non Return Valves (12 bar)

2NRVSN122 (1/4")  
3NRVSN122 (3/8")  
4NRVSN122 (1/2")

6NRVSN122 (3/4")  
8NRVSN122 (1")

#### Non Return Valves (25 bar)

2NRVSN252 (1/4")  
3NRVSN252 (3/8")  
4NRVSN252 (1/2")

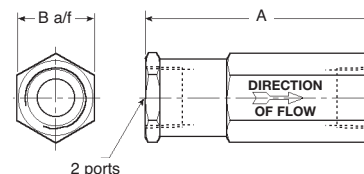
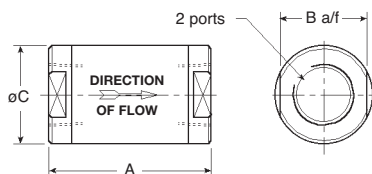
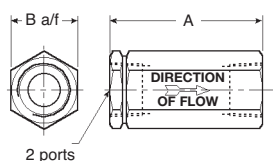

Model Number	Ports	A	B	C	Weight
<b>12 bar</b>					
2NRVSN122	1/4" NPT	50(1.97)	22.2(0.87)	-	0.12(0.26)
3NRVSN122	3/8" NPT	65(2.56)	30.5(1.20)	-	0.30(0.66)
4NRVSN122	1/2" NPT	65(2.56)	30.5(1.20)	-	0.30(0.66)
6NRVSN122	3/4" NPT	85(3.35)	45(1.77)	50.8(2.00)	1.00(2.20)
8NRVSN122	1" NPT	85(3.35)	45(1.77)	50.8(2.00)	1.00(2.20)
<b>25 bar</b>					
2NRVSN252	1/4" NPT	70(2.76)	23.4(0.87)	-	0.19(0.42)
3NRVSN252	3/8" NPT	80(3.15)	33(1.30)	-	0.46(1.01)
4NRVSN252	1/2" NPT	90(3.54)	41.3(1.63)	-	0.76(1.68)

## QUICK EXHAUST VALVES • SHUTTLE VALVES

### General Descriptions

#### Quick Exhaust Valves

316 Stainless Steel quick exhaust valves in 5 sizes.

#### Shuttle Valves

316 Stainless Steel shuttle valves for three way "OR" function.

### Operating Medium

#### Gases

Filtered lubricated or non lubricated air, inert gas, sweet (natural) gases.

Sour gas option available. (details on application)

#### Liquids

Low pressure hydraulic, mineral oil or water.

### Functional Symbols

Quick exhaust valve

Shuttle valve

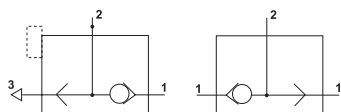

### Technical Data

#### Working Pressure (gases & liquids)

- 12 bar (174 psi)

#### Working Temperature

- -20°C to +70°C (-4°F to +158°F)

#### Low temperature version

- -50°C (-58°F) (optional)

#### Maximum Flow L/min (SCFM) - Cv(Kv)

- 6 bar (87 psi), 1 bar (14.5 psi) differential

#### Quick Exhaust Valve (supply to outlet)

- 1/4" 1290(46) 1.3(20)
- 3/8" 1810(64) 1.8(28)
- 1/2" 3810(135) 3.8(59)
- 3/4" 4520(160) 4.5(70)
- 1" 7700(274) 7.8(120)

#### Quick Exhaust Valve (outlet to exhaust)

- 1/4" 2780(98) 2.8(43)
- 3/8" 3810(135) 3.8(59)
- 1/2" 5490(194) 5.5(85)
- 3/4" 6460(228) 6.5(100)
- 1" 11000(388) 11.0(170)

#### Shuttle Valve

- 1/4" 1350(45) 1.36(21)



### Construction Materials

- Stainless Steel AISI 316L to NACE MR-01-75 Body
- Stainless Steel AISI 316L to NACE MR-01-75 Internals
- 316 Stainless Steel Spring
- Nitrile Seals

## MODEL CODES, INSTALLATION DIMENSIONS mm (inches) and WEIGHT kg (lbs)

### Quick Exhaust Valves

2QEVS122 (1/4")  
3QEVS122 (3/8")  
4QEVS122 (1/2")

6QEVS122 (3/4")  
8QEVS122 (1")

### Shuttle Valves

2SHVS122 (1/4")

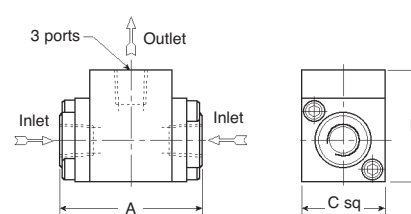
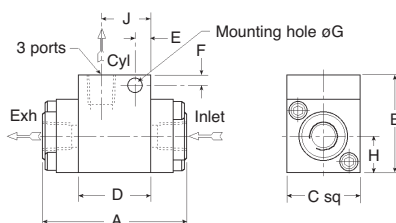
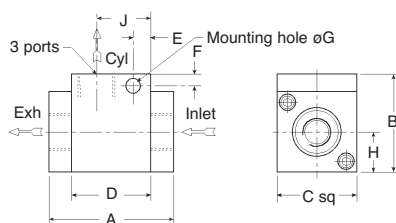

Model Number	Ports	A	B	C	D	E	F	G	H	J	Weight
2QEVS122	1/4" NPT	52 (2.05)	38 (1.50)	32 (1.26)	32 (1.26)	-	-	-	16 (0.63)	22 (0.87)	0.34 (0.75)
3QEVS122	3/8" NPT	60 (2.36)	42 (1.65)	35 (1.38)	35 (1.38)	-	-	-	17.5 (0.69)	23 (0.91)	0.48 (1.06)
4QEVS122	1/2" NPT	70 (2.76)	55 (2.17)	45 (1.77)	45 (1.77)	10 (0.39)	6.5 (0.26)	8.5 (0.33)	22.5 (0.88)	31 (1.22)	0.80 (1.76)
6QEVS122	3/4" NPT	102 (4.02)	70 (2.76)	54 (2.13)	54 (2.13)	10 (0.39)	12 (0.47)	8.5 (0.33)	27 (1.06)	35 (1.38)	1.60 (3.53)
8QEVS122	1" NPT	114 (4.49)	99 (3.90)	74 (2.91)	74 (2.91)	16 (0.63)	12 (0.47)	11 (0.43)	37 (1.46)	52 (2.05)	3.6 (7.94)

Model Number	Ports	A	B	C	Weight
2SHVS122	1/4" NPT	56 (2.20)	43 (1.69)	32 (1.26)	0.40 (0.88)

## THERMAL FUSES AND VISUAL INDICATOR

### General Descriptions

#### Thermal Fuses

316 Stainless Steel thermal fuses for fire release. Available for 6 temperature settings.

#### Visual Indicators

Compact 316 Stainless Steel panel mounted visual indicator with various colour options.

#### Operating Medium

#### Gases

Filtered lubricated or non-lubricated air, inert gas, sweet (natural) gases. Sour gas option available. *(details on application)*

#### Liquids

Low pressure hydraulic, mineral oil or water.

#### Functional Symbols

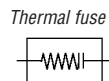

### Technical Data

#### Working pressure (gases & liquids)

- Thermal Fuses  
12 bar (174 psi)
- Visual Indicator  
1 to 12 bar (14.5 to 174 psi)

#### Working temperature

- Thermal Fuses  
-20°C to + 70°C (-4°F to +158°F)  
-20°C to + 96°C (-4°F to +205°F)  
-20°C to +102°C (-4°F to +216°F)  
-20°C to +124°C (-4°F to +255°F)  
-20°C to +137°C (-4°F to +279°F)  
-20°C to +200°C (-4°F to +392°F)
- Visual Indicator  
20°C to +65°C (36°F to +149°F)

#### Maximum flow

#### L/min (SCFM) -Cv(Kv)

- 6 bar (87 psi), 1 bar (14.5 psi) differential
- Thermal Fuses  
1/2" 5800 (205) - 5.8 (90)



### Construction Materials

- Stainless Steel AISI 316L to NACE MR-0175 Body
- Stainless steel AISI 316L to NACE MR-0175 Internals
- 316 Stainless Steel Springs
- Nitrile Seals
- Visual Indicator piston Acetal
- Visual Indicator assembly Acetal with acrylic lens

## MODEL CODES, INSTALLATION DIMENSIONS mm (inches) and WEIGHT kg (lbs)

### Thermal Fuses

4THFSN102070 (70° C)  
4THFSN102096 (96° C)  
4THFSN102102 (102° C)

4THFSN102124 (124° C)  
4THFSN102137 (137° C)  
4THFSN102200 (200° C)

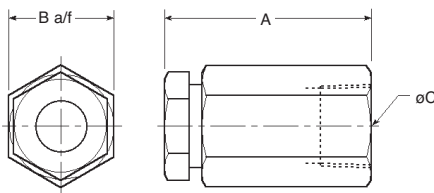

### Visual indicator

1VISSN122G (1/8"NPT Red/Green)  
1VISSN121G (1/8"BSP Red/Green)

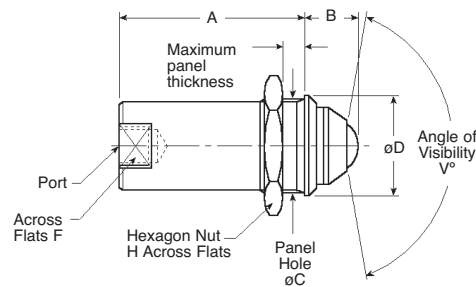

**IMPORTANT:**  
Fuse opening must be directed towards deck to safe guard personnel from shot accident by fire release.

Alternative colours available in:  
RED - GREEN - AMBER - BLACK.  
Specify colour combination required.

Model Number	Ports	A	B	Weight
4THFSN102070	1/2" NPT	51 (2.00)	25.6 (1.01)	0.15 (0.33)
4THFSN102096	1/2" NPT	51 (2.00)	25.6 (1.01)	0.15 (0.33)
4THFSN102102	1/2" NPT	51 (2.00)	25.6 (1.01)	0.15 (0.33)
4THFSN102124	1/2" NPT	51 (2.00)	25.6 (1.01)	0.15 (0.33)
4THFSN102137	1/2" NPT	51 (2.00)	25.6 (1.01)	0.15 (0.33)
4THFSN102200	1/2" NPT	51 (2.00)	25.6 (1.01)	0.15 (0.33)

Model Number	Ports	Weight
1VISSN122G	1/8" NPT	0.1 (0.22)
1VISSN121G	1/8" BSP	0.1 (0.22)

A	B	C	D	F	H	T	V
46 (1.81)	13.25 (0.52)	24 (0.94)	25.4 (1.00)	19 (0.75)	30.5 (1.20)	6 (0.24)	1600

## N.R.V. BREATHERS AND BREATHER (SILENCERS)

### General Descriptions

#### N.R.V. Breathers

316 Stainless Steel non return breather to prevent ingress into exhaust and vent ports.

#### Breathers (Silencers)

316 Stainless Steel or Brass sintered element silencers used to protect ports open to the atmosphere.

'Bug Screen' Port Vent 316 Stainless Steel sintered element used to protect vent ports to atmosphere.

### Operating Medium

#### Gases

Filtered lubricated or non-lubricated air, inert gas, sweet (natural) gases. Sour gas option available.

*(details on application)*

#### Liquids

Low pressure hydraulic, mineral oil or water.

### Functional Symbols

N.R.V. Breather      Breather (Silencer)

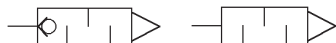

### Technical Data

#### Working pressure (gases & liquids)

- 12 bar (174 psi)

#### Working temperature

- -20°C to +70°C (-4°F to +158°F)

#### Maximum flow

##### L/min (SCFM) - Cv(Kv)

- at 6 bar (87 psi),  
1 bar (14.5 psi) differential

#### N.R.V. Breathers

- 1/4" 646 (23) - 0.65 (10)
- 3/8" 1300 (45) - 1.3 (20)
- 1/2" 1550 (54) - 1.6 (24)

#### Breathers (Silencers)

- 1/4" 1550 (55) - 1.5 (24)
- 3/8" 1940 (68) - 2.0 (30)
- 1/2" 3410 (123) - 3.5 (54)
- 3/4" 5500 (194) - 5.5 (85)
- 1" 5700 (201) - 5.7 (88)

### Construction Materials

- Stainless steel AISI 316L to NACE MR-0175
- Stainless steel AISI 316L to NACE MR-0175 Internals
- Stainless Steel Spring
- Nitrile Seals



## MODEL CODES, INSTALLATION DIMENSIONS mm (inches) and WEIGHT kg (lbs)

### N.R.V. Breathers

2NRBSN102(1/4")  
3NRBSN102(3/8")  
4NRBSN102(1/2")

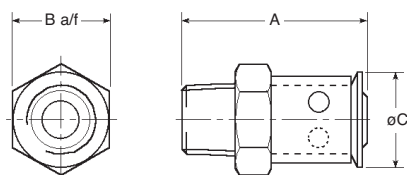

Model Number	Thread	A	B	C	Weight
2NRBSN102	1/4" NPT	34 (1.34)	17 (0.67)	17 (0.67)	0.028 (0.062)
3NRBSN102	3/8" NPT	40 (1.57)	23.4 (0.92)	21 (0.83)	0.059 (0.130)
4NRBSN102	1/2" NPT	45 (1.77)	23.4 (0.92)	21 (0.83)	0.063 (0.139)

Bug Screen	Thread	Weight
1VPBSN122	1/8" NPT	0.01 (0.026)
2VPBSN122	1/4" NPT	0.01 (0.026)

### Breathers (Silencers)

1BRESN102 (1/8")  
2BRESN102 (1/4")  
3BRESN102 (3/8")  
4BRESN102 (1/2")

6BRESN102 (3/4")  
8BRESN102 (1")

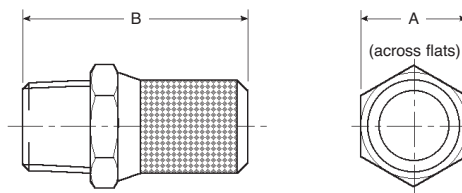

Model Number	Thread	A	B	Weight
1BRESN102	1/8" NPT	31 (1.22)	14 (0.55)	0.012 (0.026)
2BRESN102	1/4" NPT	38 (1.50)	17 (0.67)	0.022 (0.048)
3BRESN102	3/8" NPT	44 (1.73)	22 (0.87)	0.034 (0.075)
4BRESN102	1/2" NPT	55 (2.16)	24 (0.94)	0.045 (0.099)
6BRESN102	3/4" NPT	70 (2.76)	32 (1.26)	0.10 (0.22)
8BRESN102	1" NPT	75 (2.95)	36 (1.42)	0.15 (0.33)